



64Mb Dual Quad SPI MRAM

Dual-Quad SPI MRAM

1.8V

- **S3H6408R1M**
- **S3H6408R2M**

Datasheet

Feature

- 64Mb: Dual Stack of two 32Mb
- Serial Peripheral Interface with Mode 0 and Mode 3
 - Dual-Quad SPI
 - Single and double data rate (SDR/DDR)
- Performance
 - 150MHz for SDR
 - 75MHz for DDR
- Supports XIP for read and write operations
- Data protection
 - WP# pin write protection
 - Block lock protection
- Nonvolatile status and configuration registers
- Identification
 - Unique ID
 - Serial number - user writable
- Memory cell : STT-MRAM
- Density
 - 64Mb
- Data Integrity : No external ECC required
- Data Endurance
 - Unlimited read cycle
 - 10^{14} write cycles
- Data Retention
 - 10 years at 85°C
- Single Power Supply Operation
 - 1.71V~1.98V
- Operating Temperature Range
 - Industrial Temperature: -40°C to 85°C
- RoHS compliant package
 - 24-BGA (6.0mm x 8.0mm)

Performance

Operation	Typical Values	Units
Frequency(SDR)	150(Max.)	MHz
Frequency(DDR)	75(Max.)	MHz
Standby Current	1.2	mA
Deep Power Down Current	120	uA
Active Read Current (8-8-8) SDR @150MHz	18	mA
Active Write Current (8-8-8) SDR @150MHz	48	mA
Active Read Current (8-8-8) DDR @75MHz	18	mA
Active Write Current (8-8-8) DDR @75MHz	48	mA

Table of contents

Feature	2
Table of contents	3
1. General Description	6
Figure 1: Functional Block Diagram	6
Figure 2: Proposed connection for S3H6408R2M device	7
2. Pin Configuration	8
Figure 3: 24-Ball BGA, 5x5 (Balls Down)	8
Table 1: Pin Description	8
3. Power On/Off Sequence	9
Figure 4: Power-up/down Behavior	9
Table 2: Power Up/Down Timing	9
4. Memory Organization	10
Table 3: Memory Map	10
Table 4: Augmented Area Map	10
Table 5: Register Address Map	10
5. Register Description	11
5.1 STATUS REGISTER	11
Table 6: Status Register	11
5.1.1 Write Protection Modes	12
Table 7: Write Protection Modes	12
5.1.2 Block Protection	13
Table 8: Block Protection Address Range Selection	13
5.1.3 Augmented Area Protection	13
Table 9: Augmented Area Protection Register – Read and Write	13
5.2 CONFIGURATION REGISTER	14
5.2.1 Configuration Register 1	14
Table 10: Configuration Register 1	14
5.2.2 Configuration Register 2	14
Table 11: Configuration Register 2	14
Table 12: Read Latency Cycles vs. Maximum Frequency (Memory Area)	15
Table 13: Read Latency Cycles vs. Maximum Frequency (Augmented Area)	15
Table 14: Read Latency Cycles vs. Maximum Frequency (Read Any Register)	15
5.2.3 Configuration Register 3	16
Table 15: Configuration Register 3	16
5.2.4 Configuration Register 4	17
Table 16: Configuration Register 4	17
5.3 DEVICE IDENTIFICATION REGISTER	18
Table 17: Device Identification Register	18
5.4 SERIAL NUMBER REGISTER	18
Table 18: Serial Number Register	18
5.5 UNIQUE IDENTIFICATION REGISTER	18
Table 19: Unique ID Register	18
6. SPI Protocol	19
6.1 SPI CLOCK MODES	19
Figure 5: SPI Clock Modes	19
6.2 SPI INTERFACE MODES	20
Table 20: Pin Assignment / Interface Modes	20
6.3 MSB/LSB LOCATION	20
Figure 6: Location of MSB and LSB	20
7. Device Operation	21
7.1 INSTRUCTION COMMAND SET	21
Table 21: Instruction Command Table	21
7.2 RESET OPERATIONS	23

7.2.1 Software Reset.....	23
Figure 7: Software Reset Timing.....	23
7.2.2 JEDEC Reset.....	23
Figure 8: JEDEC Reset Timing.....	23
Table 22: JEDEC Reset Timing.....	23
7.3 WRITE ENABLE/DISABLE OPERATIONS	24
Figure 9: WRITE Enable/Disable Timing.....	24
7.4 ENABLE EXTENDED, QUAD SPI MODE AND NO OPERATION.....	25
Figure 10: Enable Extended SPI or Quad SPI mode.....	25
Figure 11: No operation.....	25
7.5 REGISTER OPERATION	26
7.5.1. Read Register Operations	26
Figure 12: Read Status Register Timing.....	26
Figure 13: Read Configuration Register 1, 2, 3 or 4 Timing	26
Figure 14: Read Configuration Register 1-4 Timing	27
Figure 15: Read Device ID Timing	27
Figure 16: Read Unique ID Timing	28
Figure 17: Read Serial Number Register Timing.....	28
Figure 18: Read Augmented 512-byte Protection Register Timing	28
Figure 19: Read Any Register Timing.....	29
7.5.2. WRITE REGISTER Operations	30
Figure 20: Write Status Register Timing.....	30
Figure 21: Write Configuration Register 1-4 Timing.....	30
Figure 22: Write Serial Number Register Timing	30
Figure 23: Write Augmented 512-byte Protection Register Timing.....	31
Figure 24: Write Any Register Timing	31
7.6 MEMORY OPERATION	32
7.6.1 READ MEMORY Operations	32
Figure 25: Read Memory Timing.....	32
7.6.2 Write Memory Operations	34
Figure 26: Write Memory Timing	34
7.6.3 XIP Operations	36
Figure 27: Read XIP Timing	36
7.7 AUGMENTED AREA OPERATION	38
Figure 28: Read Augmented 512-byte Area Timing.....	38
Figure 29: Write Augmented 512-byte Area Timing.....	38
7.8 DEEP POWER-DOWN OPERATION.....	39
8. Electrical Specifications.....	40
8.1 ABSOLUTE MAXIMUM RATINGS.....	40
Table 23: Absolute Maximum Ratings	40
8.2 ENDURANCE, RETENTION AND MAGNETIC IMMUNITY	40
Table 24: Write Endurance, Retention and Magnetic Immunity.....	40
8.3 RECOMMENDED OPERATING CONDITIONS	41
Table 25: Recommended Operating Conditions.....	41
8.4 PIN CAPACITANCE	41
Table 26: Pin Capacitance.....	41
8.5 AC TEST CONDITION	41
Table 27: AC Test Conditions	41
8.6 DC CHARACTERISTICS	42
Table 28: DC Characteristics.....	42
8.7 AC TIMING CHARACTERISTICS	43
8.7.1 Synchronous Input Timing	43
Figure 30: Synchronous Input Timing (SDR/DDR).....	43
8.7.2 Synchronous Output Timing.....	43
Figure 31: Synchronous Data Output Timing (SDR/DDR).....	43
8.7.3 WP# Timing	43
Figure 32: WP# Operation Timing.....	43
8.7.4 CS# High Time.....	44
Table 29: CS# High time after instructions	44
8.7.5 AC Timing Parameters.....	45



Table 30: AC Timing Parameter 45

Table 31: CS# High Time after Write Memory Instruction..... 46

Table 32: CS# High Time after Register/Augmented Area Write Instruction..... 46

9. Thermal Resistance 47

 Table 33: Thermal Resistance 47

10. Part Numbering System 48

11. Ordering Part Numbers 49

 Table 34: Ordering Part Number 49

12. Package Dimension 50

24-BALL BGA (6MM X 8MM) 50

Revision History 51

1. General Description

The device is a Spin-Transfer-Torque Magneto-resistive Random Access Memory (STT-MRAM).

It features a SPI bus interface, XIP (execute-in-place) functionality and hardware and software based data protection mechanisms.

SPI (Serial Peripheral Interface) is a synchronous serial communication interface with command, address, and data signals.

Dual-quad SPI devices consist of two 32Mb quad SPI devices, providing 8-bit I/O data access. Both 1-CS#/1-CLK and 2-CS#/2-CLK configurations are supported for convenient system configuration.

Each individual die provides various SPI modes, allowing options for bandwidth expansion. Extended SPI mode has single pin for command signal for each die. User can select an option for how many pins to be allocated to address and data signals among 1 pin or 4 pins for each die. Quad SPI mode provides 4 pins for command, address, and data signals for each individual die.

Each individual die has its own nonvolatile register bits – status register, configuration register, serial number register, augmented 512-byte register, protection register for augmented bytes, device ID, and unique ID. The status register and configuration register are required to be set at least once on power-up after high temperature solder-reflow process for each individual die.

The device is available in small footprint 24-BGA package. The package is compatible with similar non-volatile products. The device is offered with an industrial (-40°C to 85°C) operating temperature range.

Figure 1: Functional Block Diagram

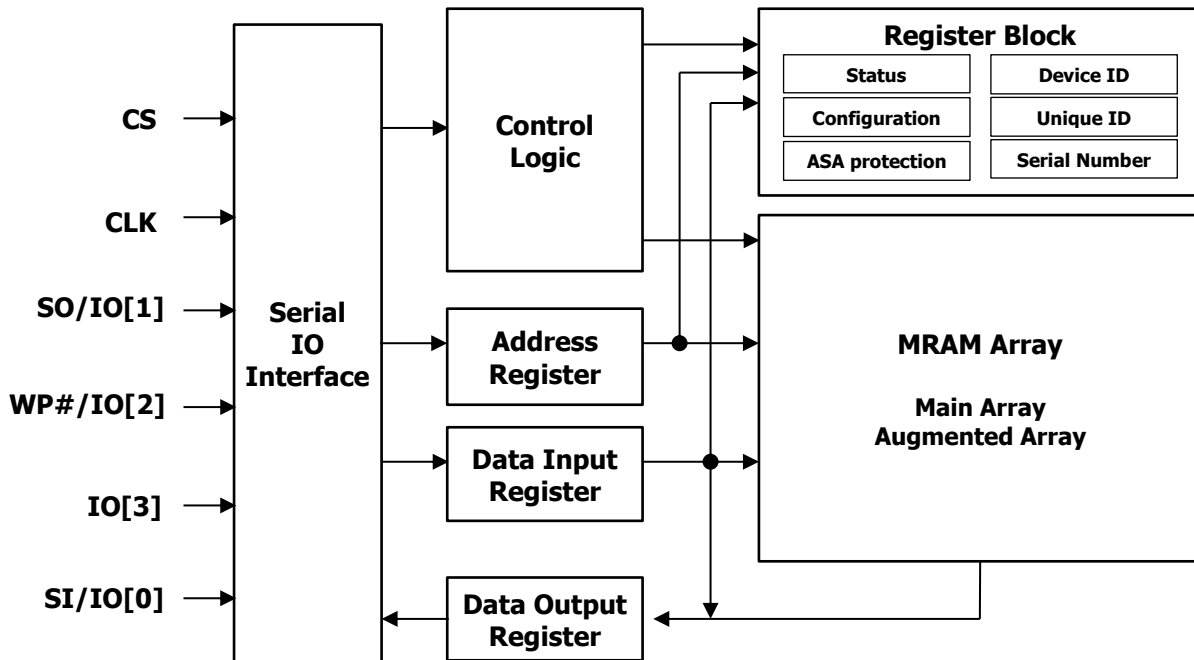

Functional Block Diagram for each individual die (32Mb)

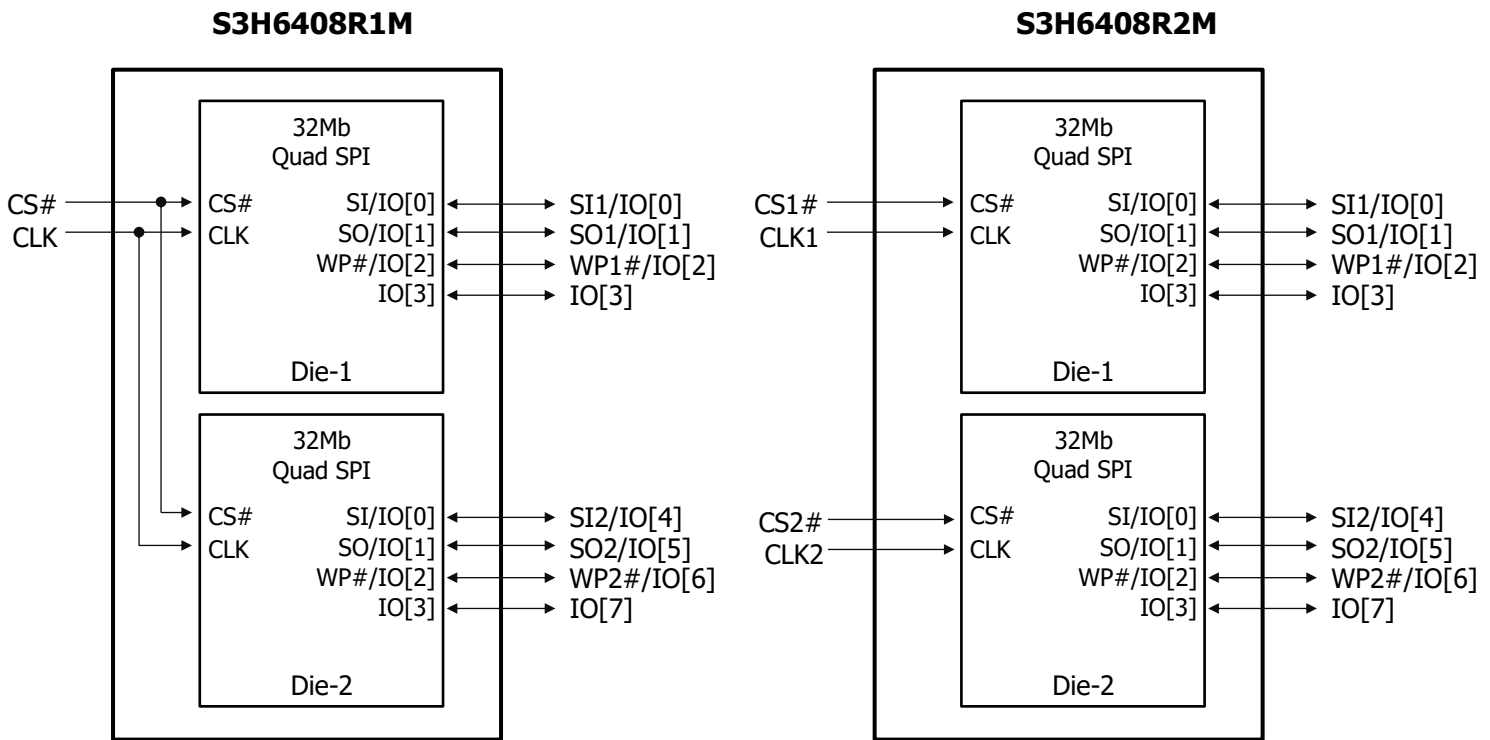
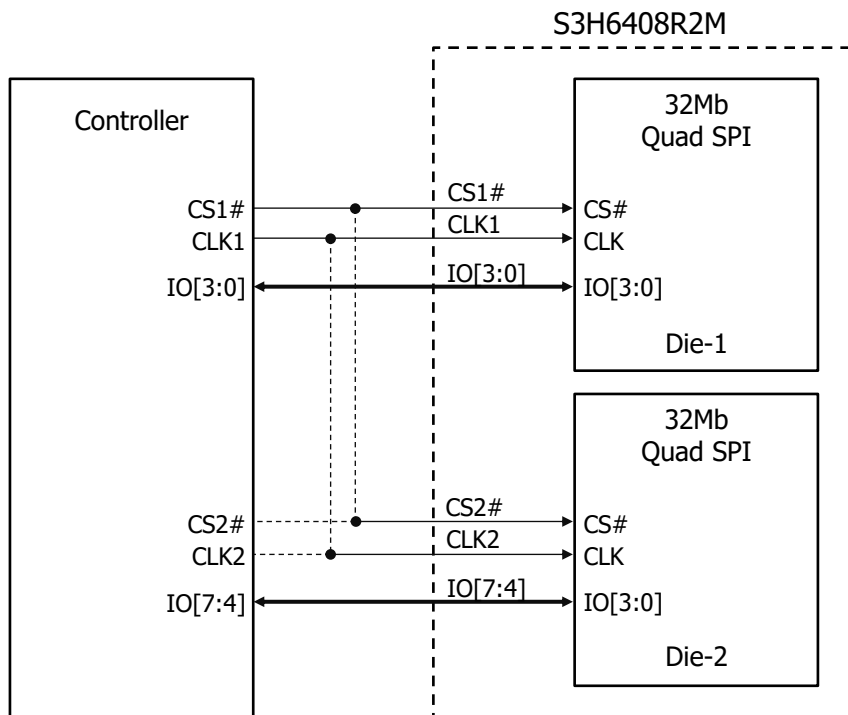
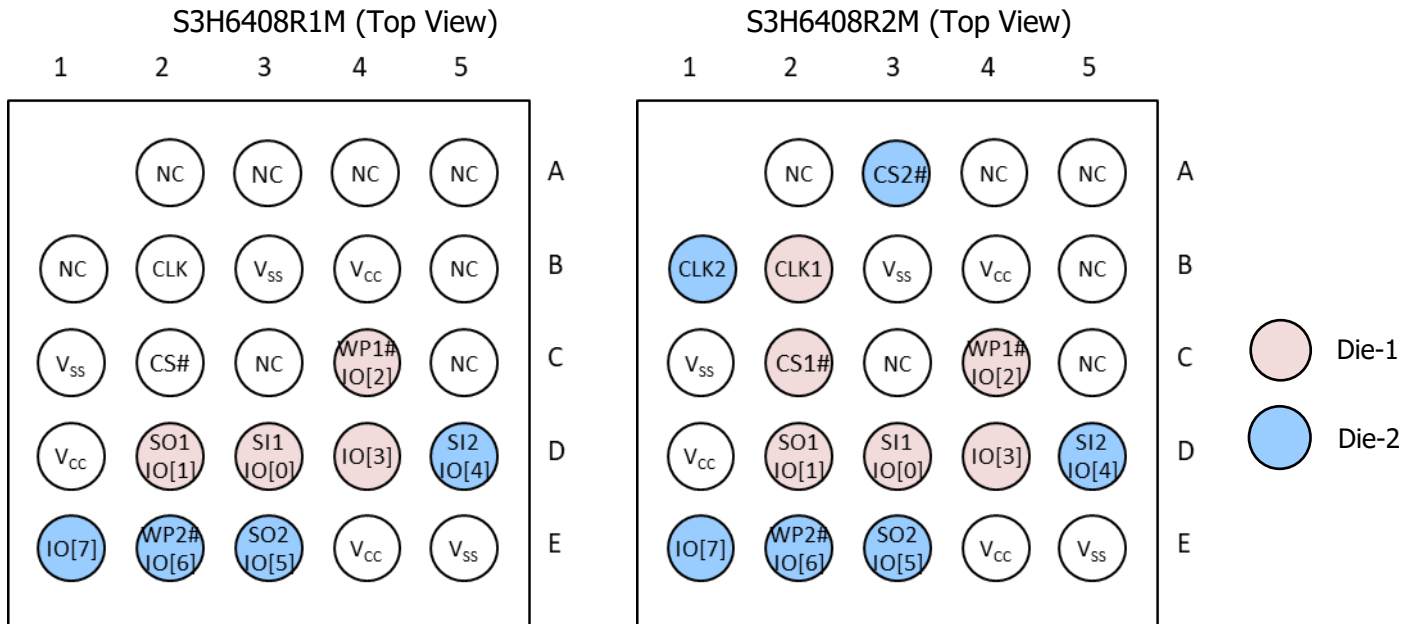

Figure 2: Proposed connection for S3H6408R2M device



2. Pin Configuration

Figure 3: 24-Ball BGA, 5x5 (Balls Down)

Table 1: Pin Description

Pin	Type	Description
CS# or CS1#, CS2#	Input	Chip Select: When CS# is driven Low, a read or write operation is initiated. When CS# is driven High, the device enters standby mode, and all other input pins are ignored and the output pins are tri-stated. CS# should be High at power-up to prevent abnormal write operation. This pin does not have internal pull-up resistor.
CLK or CLK1, CLK2	Input	Clock: In SDR (single data rate) mode, the command, address, and data inputs are latched on the rising edge of the clock. Data is output on the falling edge of the clock. In DDR (double data rate) mode, the command is latched on the rising edge of the clock and address and data inputs are latched on the rising and falling edges of the clock. Similarly, data is output on both edges of the clock. The two SPI clock modes are supported as follows. <ul style="list-style-type: none"> • SPI Mode 0 : SDR and DDR • SPI Mode 3 : SDR only
WP1#/IO[2] WP2#/IO[6]	Input /Bidirectional	Write Protect (Extended SPI): The writing of status and configuration register is protected in related with WP# and WPEN. See "Table 7: Write Protection Modes". This pin does not have an internal pull-up resistor, it cannot be left floating and must be driven. WP# is valid in Extended SPI. IO[2], IO[6] : The bidirectional I/O in Quad input/output mode.
IO[3], IO[7]	Bidirectional	IO[3], IO[7] : The bidirectional I/O in Quad input/output modes.
SI1/IO[0] SI2/IO[4]	Input /Bidirectional	SI1, SI2: The serial input in Single input mode. IO[0], IO[4] : The bidirectional I/O in Quad input/output modes
SO1/IO[1] SO2/IO[5]	Output /Bidirectional	SO1, SO2 : The serial data output in Single output mode. IO[1], IO[5] : The bidirectional in Quad input/output modes.
Vcc	Supply	Power pin
Vss	Supply	Ground pin

3. Power On/Off Sequence

During power-up, power-down or power-loss, CS# for S3H6404R1M or CS1# and CS2# for S3H6404R2M must follow Vcc to ensure data protection.

It is recommended that CS# or both CS1# and CS2# must follow Vcc when Vcc is below Vcc(minimum) and during t_{PU}.

A 10KΩ pull-up resistor between Vcc and CS# or CS1# and CS2# pin is recommended.

Software reset operation is required after t_{PU} for both dies.

Normal operation must start after t_{SRST}.

Figure 4: Power-up/down Behavior

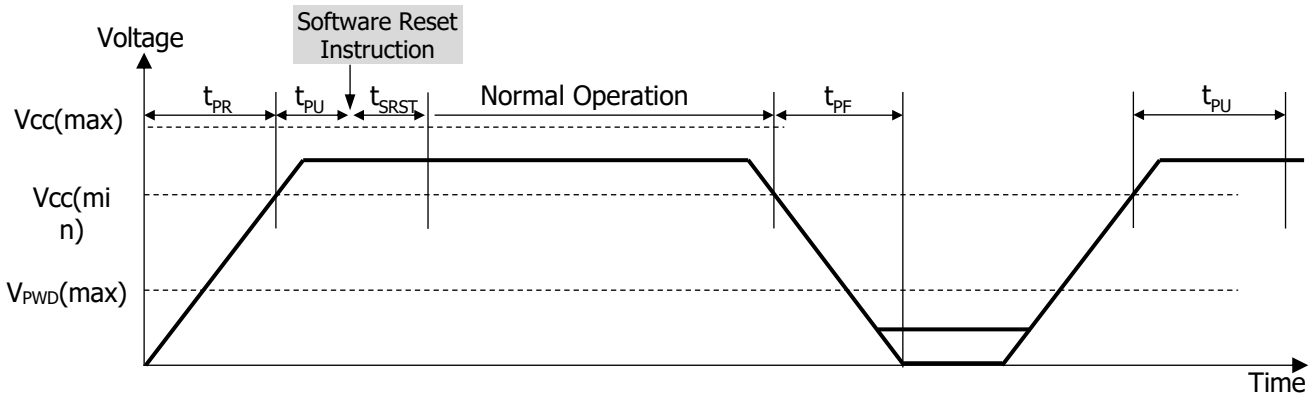

Table 2: Power Up/Down Timing

Parameter	Symbol	Min	Max	Units
Vcc Range	Vcc	1.71	1.98	V
Vcc rising time	t _{PR} ⁽¹⁾	30	-	μs/V
Vcc falling time	t _{PF} ⁽¹⁾	30	-	μs/V
Vcc(min) to CS# Low (first instruction) time	t _{PU} ⁽¹⁾	2.0	-	ms
Vcc needed to below V _{PWD} for ensuring initialization will occur	V _{PWD} ⁽¹⁾	-	0.8	V
Software Reset time	V _{SRST} ⁽¹⁾	2.0	-	ms

Notes:

1. These parameters are guaranteed by characterization; not tested in production.

4. Memory Organization

Table 3: Memory Map

Density	Address Range	24-bit Address [23:0]	
32Mb -each individual die	000000h – 3FFFFFFh	[23:22] – Logic '0'	[21:0] – Addressable

Table 4: Augmented Area Map

Augmented Area	Address Range	24-bit Address [23:0]	
512-byte -each individual die	000000h – 0001FFh	[23:9] – Logic '0'	[8:0] – Addressable

Notes:

- The augmented 512-byte area is divided into 8 individually readable and writable sections (64 bytes per section). After an individual section is written, it can be protected individually to prevent further writing. The address bits Address[23:9] must be logic '0'.

Table 5: Register Address Map

The device provides the register read/write instructions to read and write data of each register.

In addition, the device provides the register read and/or write function based on addresses using RDAR(65h) and WRAR(71h) commands.

Register Name	Address for each individual die
Status Register	0x000000h
Configuration Register 1	0x000002h
Configuration Register 2	0x000003h
Configuration Register 3	0x000004h
Configuration Register 4	0x000005h
Device Identification Register	0x000030h
Unique Identification Register	0x000040h
Serial Number Register	0x000080h

Notes:

- Register address space is different from the memory array and augmented 512-byte area.

5. Register Description

Each individual die has its own nonvolatile register – Status Register, Configuration Register, Serial Number Register, Augmented Area Register, Protection Register for augmented area, Device ID, and Unique ID. The nonvolatile bits of Status Register and Configuration Register are required to be set at least once on power-up after high temperature solder-reflow process for both dies. The device configuration is set from Status Register and Configuration Registers after power-up or by Write Register instructions. The following descriptions apply to each individual die.

5.1 Status Register

The device offers both hardware and software based data protection schemes. Hardware protection is through WP# pin. Software protection is controlled by configuration bits in the Status register. Both schemes inhibit writing to the registers, memory and augmented area. Status Register contains options for enabling/disabling data protection. By controlling configuration bits in Status Register, user can protect data in memory based on software protection schemes. The Status Register can be written using either the Write Status Register instruction or Write Any Register (Address based) instruction combined with CR1[2] of Configuration Register 1, and it can be read using either Read Status Register instruction or Read Any Register(Address based) instruction.

Table 6: Status Register

Bits	Name	Read/Write	Default State	Description
SR[7]	WPEN	R/W	-	Hardware Based WP# Protect Bit 1: Protection Enabled – write protects when WP# is Low 0: Protection Disabled – Doesn't write protect when WP# is Low
SR[6]	SNPEN	R/W	-	Serial Number Protect Bit 1: Serial Number Write protected 0: Serial Number Writable
SR[5]	TB	R/W	-	Top/Bottom Memory Array Protect Selection 1: Bottom Protection Enabled (Lower Address Range) 0: Top Protection Enabled (Higher Address Range)
SR[4]	BP[2]	R/W	-	Block Protection Bits
SR[3]	BP[1]	R/W	-	
SR[2]	BP[0]	R/W	-	
SR[1]	WREN	R	0	Write Protection Enable 1: Write Operation Protection Disabled 0: Write Operation Protection Enabled
SR[0]	RSVD	R	-	Reserved for future use

Notes:

1. SR[7:2] are nonvolatile bits.
2. TB and BP[2:0] can be protected by CR1[2] of Configuration Register 1.

5.1.1 Write Protection Modes

WPEN bit (SR[7]) is used in conjunction with the WREN bit (SR[1]) and the WP# pin to provide hardware block protection. SR[7:2] will remain set from the nonvolatile registers whenever the power is on. The WREN bit is volatile and set to '1' by the Write Enable command. It is reset to '0' after power up, software reset, JEDEC reset, Write Disable command or when Write Register operation finishes. For WREN information on write operations for memory and augmented area, please refer to Configuration Register 4.

The device enters hardware protection when the WP# input is Low and the WPEN bit of Status Register is set to '1', and the nonvolatile registers cannot be changed. The device exits from hardware protection when the WP# pin goes High or WPEN bit is set to '0' and the register bits can be changed.

Table 7: Write Protection Modes

WREN	WPEN	WP#	Registers ⁽¹⁾	Memory ⁽²⁾ and Augmented 512-byte Area ⁽³⁾	
				Protected Area	Unprotected Area
0	X	X	Protected	Protected	Protected
1	0	X	Unprotected	Protected	Unprotected
1	1	0	Protected	Protected	Unprotected
1	1	1	Unprotected	Protected	Unprotected

Notes:

1. Status, Configuration, Protection for Augmented 512-Byte Area and Serial Number Register.
2. Memory address range protection based on Block Protection Bits
3. The Augmented 512-byte Area range protection based on Augmented 512-Byte Area Protection Register.
The Augmented 512-byte Area can also be protected by CR1[0] of Configuration Register 1.
4. The Serial Number register can also be protected by SR[6] of Status Register.
5. X: Don't Care – can be logic '0' or '1'
6. Protected: write protected, Unprotected: writable

5.1.2 Block Protection

The write protection blocks for the memory array are determined by the status register bits (TB and BP[2:0]) as Table 8 below. TB and BP[2:0] can be modified by Write Status Register instruction(01h) or Write Any Register instruction(71h) when the WP# is High or the Status Register WPEN bit is set to 0 and CR1[2] of Configuration Register 1 is set to '0'.

Table 8: Block Protection Address Range Selection

TB	BP[2]	BP[1]	BP[0]	Protected Portion	32Mb for each individual die
0/1	0	0	0	None	None
0	0	0	1	Upper 1/64	3F0000h – 3FFFFFFh
0	0	1	0	Upper 1/32	3E0000h – 3FFFFFFh
0	0	1	1	Upper 1/16	3C0000h – 3FFFFFFh
0	1	0	0	Upper 1/8	380000h – 3FFFFFFh
0	1	0	1	Upper 1/4	300000h – 3FFFFFFh
0	1	1	0	Upper 1/2	200000h – 3FFFFFFh
1	0	0	1	Lower 1/64	000000h – 00FFFFh
1	0	1	0	Lower 1/32	000000h – 01FFFFh
1	0	1	1	Lower 1/16	000000h – 03FFFFh
1	1	0	0	Lower 1/8	000000h – 07FFFFh
1	1	0	1	Lower 1/4	000000h – 0FFFFFFh
1	1	1	0	Lower 1/2	000000h – 1FFFFFFh
0/1	1	1	1	All	000000h – 3FFFFFFh

5.1.3 Augmented Area Protection

The Augmented Area Protection register contains options for enabling/disabling data protection for eight sections.

Table 9: Augmented Area Protection Register – Read and Write

Bits	Name	Address Range for each individual die	Read/Write	Default State	Description
ASP[7]	ASPS[7]	0001C0h – 0001FFh	R/W	0	1: Protection Enabled 0: Protection Disabled
ASP[6]	ASPS[6]	000180h – 0001BFh	R/W	0	
ASP[5]	ASPS[5]	000140h – 00017Fh	R/W	0	
ASP[4]	ASPS[4]	000100h – 00013Fh	R/W	0	
ASP[3]	ASPS[3]	0000C0h – 0000FFh	R/W	0	
ASP[2]	ASPS[2]	000080h – 0000BFh	R/W	0	
ASP[1]	ASPS[1]	000040h – 00007Fh	R/W	0	
ASP[0]	ASPS[0]	000000h – 00003Fh	R/W	0	

Notes:

- ASP[7:0] are nonvolatile bits.

5.2 Configuration Register

The Configuration Register can be configured using either the Write Configuration Register instructions or Write Any Register (Address based) instruction, and it can be read using either Read Configuration Register instructions or Read Any Register(Address based) instruction.

5.2.1 Configuration Register 1

Configuration Register 1 controls the locking and unlocking of data protection options set in the Status Register and Augmented 512-Byte Area Protection Register. Once locked, these protection options cannot be changed in the Status register.

Table 10: Configuration Register 1

Bits	Name	Read/Write	Default State	Selection Options
CR1[7:3]	RSVD	R/W	-	Reserved for future use
CR1[2]	MAPLK	R/W	-	Status Register TB, BP[2:0] Protect 1: Lock TB and BP[2:0] 0: Unlock TB and BP[2:0]
CR1[1]	RSVD	R/W	-	Reserved for future use
CR1[0]	ASPLK	R/W	-	Augmented Area Data Protection 1: Write Protection for Augmented Area Data regardless of ASP[7:0] 0: Write Protection for Augmented Area Data depending on ASP[7:0]

Notes:

1. CR1[7:0] are nonvolatile bits.

5.2.2 Configuration Register 2

Configuration Register 2 controls the interface types along with memory array access latency.

Table 11: Configuration Register 2

Bits	Name	Read/Write	Default State	Description
CR2[7]	RSVD	R/W	-	Reserved for future use
CR2[6]	QPIEN	R	0	Quad SPI (QPI 4-4-4) Interface Mode 1: Quad SPI (QPI 4-4-4) Enabled 0: Extended SPI (SPI 1-X-X) Enabled
CR2[5]	RSVD	R/W	0	It must be written as '0'
CR2[4]	RSVD	R	0	Reserved for future use
CR2[3]	RL[3]	R/W	-	Read Latency Selection Bits 0000: 0 Cycle 1000: 8 Cycles 0001: 1 Cycle 1001: 9 Cycles 0010: 2 Cycles 1010: 10 Cycles 0011: 3 Cycles 1011: 11 Cycles 0100: 4 Cycles 1100: 12 Cycles 0101: 5 Cycles 1101: 13 Cycles 0110: 6 Cycles 1110: 14 Cycles 0111: 7 Cycles 1111: 15 Cycles
CR2[2]	RL[2]		-	
CR2[1]	RL[1]		-	
CR2[0]	RL[0]		-	
			-	

Notes:

1. Read Latency is frequency-dependent.
2. Read(03h) does not depend on the Read latency Selection Bits CR2[3:0].
3. CR2[7,5,3:0] are non-volatile bits.
4. CR2[5] must be written as '0'.

The number of read latency cycles must be set to accord with the clock frequency for all Read Memory instructions (except for Read 03h) and Read Augmented 512-Byte Area (4Bh). Insufficient read latency cycles for the operating frequency causes the device to read incorrect data.

Table 12: Read Latency Cycles vs. Maximum Frequency (Memory Area)

Read Latency Cycles	SDR			DDR			Unit
	1s-1s-1s	1s-1s-4s 1s-4s-4s	4s-4s-4s	1s-1d-1d	1s-1d-4d	1s-4d-4d 4s-4d-4d	
0	108	20	20	-	-	-	MHz
1	125	33	33	54	-	-	MHz
2	125	50	50	66	33	33	MHz
3	125	66	66	75	40	40	MHz
4	125	83	83	75	54	54	MHz
5	125	100	100	75	54	54	MHz
6	125	108	108	75	54	66	MHz
7	125	108	125	75	54	66	MHz
8	125	108	125	75	54	66	MHz
9	125	108	125	75	54	75	MHz
10	133	108	133	75	54	75	MHz
11~15	150	108	150	75	54	75	MHz

Notes:

1. Read(03h) does not depend on Read latency Selection Bits CR2[3:0]. The latency of Read(03h) is always 0-cycle.

Table 13: Read Latency Cycles vs. Maximum Frequency (Augmented Area)

Read Latency Cycles	RDAS 4Bh	Unit
	1s-1s-1s	
0~2	NA	-
3	33	MHz
4	54	MHz
5	66	MHz
6	83	MHz
7	100	MHz
8	108	MHz
9	125	MHz
10	133	MHz
11~15	150	MHz

Table 14: Read Latency Cycles vs. Maximum Frequency (Read Any Register)

Read Type	XIP	Latency Cycles	Max Frequency
1s-1s-1s (RDAR 65h)	-	8	150MHz
4s-4s-4s (RDAR 65h)	-	2	150MHz

Notes:

1. RDAR(65h, read any register instruction) does not depend on Read latency Selection Bits CR2[3:0].

5.2.3 Configuration Register 3

Configuration Register 3 controls the output driver strength along with the boundary size of read data wrapping.

Table 15: Configuration Register 3

Bits	Name	Read/Write	Description
CR3[7]	DRV[2]	R/W	Output Driver Strength Selection DRV[2:0] 1.8V 000: 35Ω 001: 95Ω 010: 63Ω 011: 50Ω 100: 40Ω 101: 30Ω 110: 26Ω 111: 22Ω
CR3[6]	DRV[1]		
CR3[5]	DRV[0]		
CR3[4]	WRPEN	R/W	Read WRAP Enable 1: Read Wrap Enabled 0: Read Wrap Disabled
CR3[3]	RSVD	R/W	Reserved for future use
CR3[2]	WRPL[2]	R/W	Wrap length configuration WRPL[2:0] 000: 16-byte wrap 001: 32-byte wrap 010: 64-byte wrap 011: 128-byte wrap 100: 256-byte wrap 101: 512-byte wrap 110: 1K-byte wrap 111: Reserved
CR3[1]	WRPL[1]		
CR3[0]	WRPL[0]		

Notes:

1. Default output strength is DRV[2:0]=000.
2. CR3[7:0] are non-volatile bits.

	Description
WRPEN(CR3[4]) =Low	Read and write operation: continuous mode Read or write operation starts at the input address, and once the address reaches the maximum address boundary, it automatically returns to minimum address (000000h) until CS# goes to High.
WRPEN(CR3[4]) =High	Read operations: wrap mode Read wrap mode is enabled when WRPEN(CR3[4]) is High, and the read data wrap length is controlled by WRPL[2:0]. The output data starts at the input address, data are output sequentially. Once it reaches the ending boundary, the output will wrap around to the beginning boundary automatically until CS# is pulled High. Write operation: continuous mode Write operation starts at the input address, and once the address reaches the maximum address boundary, it automatically returns to minimum address (000000h) until CS# goes to High.

5.2.4 Configuration Register 4

Configuration Register 4 controls Write Protection Enable/Disable (WREN) functionality during memory and augmented area writes.

This functionality makes SPI MRAM compatible to other SPI devices.

Table 16: Configuration Register 4

Bits	Name	Read/Write	Default State	Selection Options
CR4[7:2]	RSVD	R/W	-	Reserved for future use
CR4[1]	WRENS[1]	R/W	-	00: Normal mode WREN is prerequisite for every Memory or Augmented Area Write instruction (WREN is reset after CS# goes High). 01: SRAM mode WREN is not a prerequisite for Memory Write or Augmented Area Write instructions (WREN is ignored).
CR4[0]	WRENS[0]		-	10: Back-to-Back mode WREN is prerequisite only to the first Memory Write or Augmented Area Write instruction. To reset WREN, WREN Disable instruction must be executed. (WREN does not reset after CS# goes High). 11: Reserved

Notes:

1. Write Protection Enable (WREN – Status Register) for Register is maintained irrespective of the Configuration Register 4 settings.

In other words, all register write Instructions require WREN to be set, and WREN is reset after CS# goes High.

CR4[1:0] only affects writing for memory and augmented area.

2. CR4[7:0] are nonvolatile bits.

5.3 Device Identification Register

Each individual die has Device Identification register which contains Netsol's Manufacturing ID along with device configuration information.

Table 17: Device Identification Register

Bits	Manufacturer ID	Device Configuration				
ID[31:0]	ID[31:24]	Interface	Voltage	Temperature	Density	Reserved
		ID[23:20]	ID[19:16]	ID[15:12]	ID[11:8]	ID[7:0]

Manufacturer ID	Interface	Voltage	Temperature	Density	Reserved
31-24	23-20	19-16	15-12	11-8	7-0
1101 1001	0000 : Quad SPI	0010 : 1.8V	0000 : -40°C~85°C	0110 : 32Mb	00000001

5.4 Serial Number Register

Each individual die provides 64-bit Serial Number register and the user can write it.

Table 18: Serial Number Register

Bits	Name	Description	Read/ Write	State
SN[63:0]	SN	Serial Number Value	R/W	User writable

Notes:

1. Serial Number Bits are nonvolatile.
2. User should write the data after solder-reflow process, if used.

5.5 Unique Identification Register

Unique Identification register contains a number unique for each individual die.

Table 19: Unique ID Register

Bits	Name	Read/Write	Description
UID[63:0]	UID	R	Unique Identification Number Value The value stored is factory-written in the factory and specific to each device.

6. SPI Protocol

All communication between a host and the device occurs through commands. The commands define the operations that need to be executed. Instructions consist of a command followed by an optional address modifier and the associated data, which are transferred sequentially. To initiate a command, CS# should be driven Low and CLK should be toggled. When the correct command is input to this device, it enters active mode and remains in that state until next CS# rising edge. When CS# goes High, the device goes into standby mode.

6.1 SPI Clock Modes

The following two SPI clock modes are supported.

- SPI Mode 0 (CPOL = 0, CPHA = 0) – SDR and DDR
- SPI Mode 3 (CPOL = 1, CPHA = 1) – SDR only

Figure 5: SPI Clock Modes

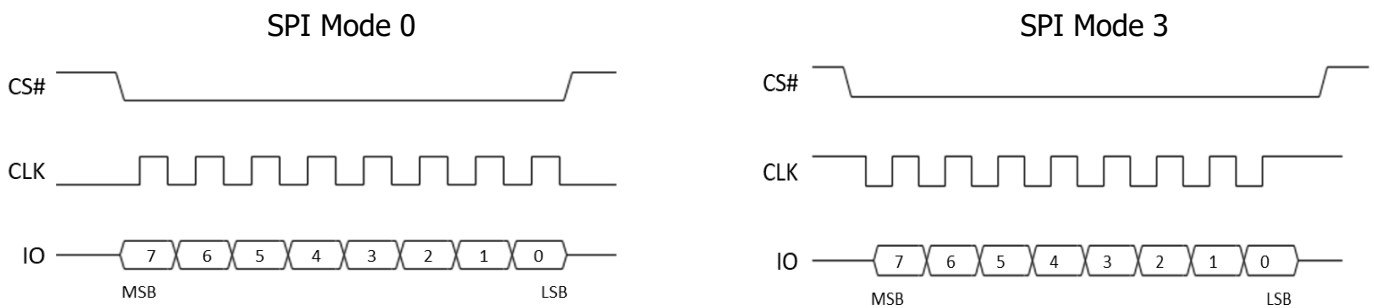

Mode0: Clock stays in Low level during idle state and starts toggling by going High.

Mode 3: Clock stays in High level during idle state and starts toggling by going Low.

6.2 SPI Interface Modes

Each individual die supports 2 categories of SPI interface modes.

1. Extended SPI: the command is transferred through one pin.
 - 1) Address and data are transferred through one pin (1-1-1).
 - 2) Address is transferred through one pin, data is transferred through four pins (1-1-4).
 - 3) Address and data are transferred through four pins (1-4-4).
2. Quad SPI: All command, address and data are transferred through four pins (4-4-4).

The device supports DDR (double data rate) for address and data.

Table 20: Pin Assignment / Interface Modes

Instruction Component	Interface Modes (Command-Address-Data)			
	Extended SPI			Quad SPI
	1s-1s-1s 1s-1d-1d	1s-1s-4s 1s-1d-4d	1s-4s-4s 1s-4d-4d	4s-4s-4s 4s-4-4d
Command	SI/IO[0]	SI/IO[0]	SI/IO[0]	IO[3:0]
Address	SI/IO[0]	SI/IO[0]	IO[3:0]	IO[3:0]
Data Input	SI/IO[0]	IO[3:0]	IO[3:0]	IO[3:0]
Data Output	SO/IO[1]	IO[3:0]	IO[3:0]	IO[3:0]

Notes:

1. 1 or 4 : bit width, s: SDR, d: DDR

6.3 MSB/LSB Location

The most significant bit(MSB) is placed first at all commands, address and data.

Figure 6: Location of MSB and LSB

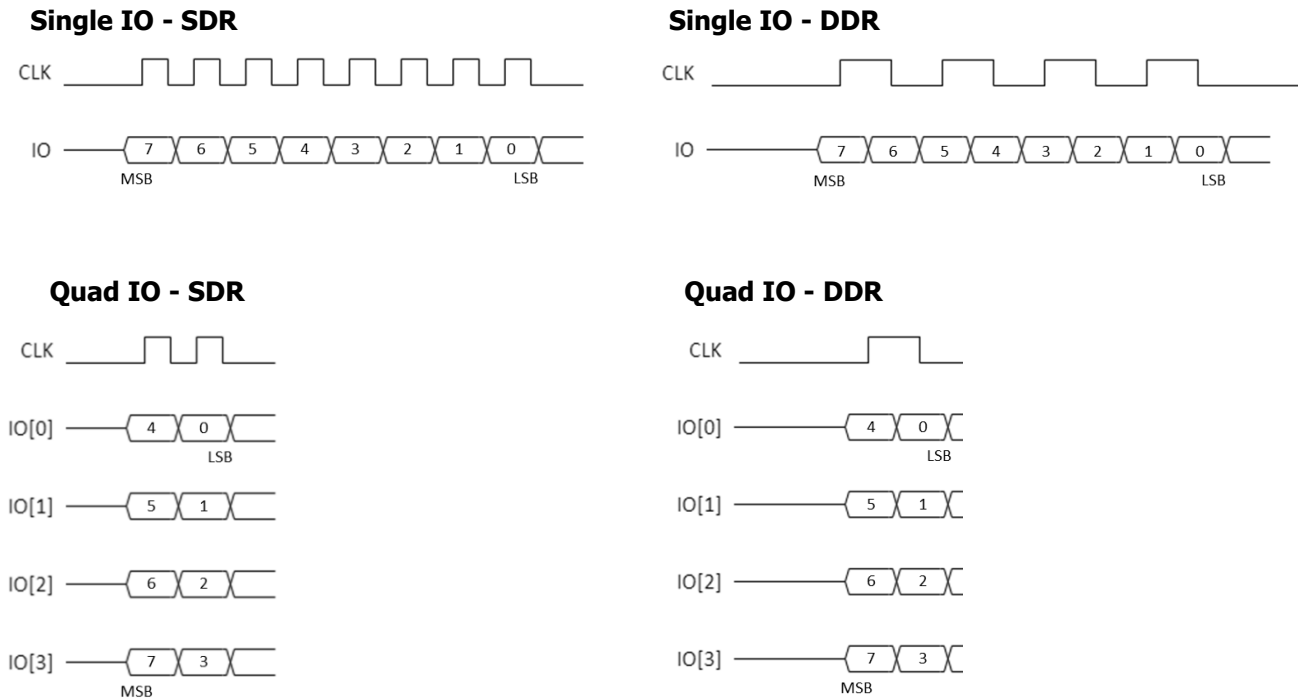

7. Device Operation

7.1 Instruction Command Set

Each instruction begins with an 8-bit command which selects the type of operation. The command can be used independently, or followed by address and data, or followed by data only. During XIP operation, the first 24 bits represent the read or write address. Avoid entering invalid command codes (except for the following instruction sets). The table below shows the instruction command table for each individual die.

Table 21: Instruction Command Table

Instruction Command Set		Code	Command-Address-Data					Max. Frequency
Command	Name		Extended SPI	Quad SPI	XIP	Latency Cycles	Data Bytes	
Control Instructions								
No operation	NOOP	00h	1s-0-0	4s-0-0	-	-	-	150MHz
Write Enable	WREN	06h	1s-0-0	4s-0-0	-	-	-	150MHz
Write Disable	WRDI	04h	1s-0-0	4s-0-0	-	-	-	150MHz
Enable Quad SPI	QPIE	38h	1s-0-0	-	-	-	-	150MHz
Enable Extended SPI	SPIE	FFh	-	4s-0-0	-	-	-	150MHz
Enter Deep Power Down	DPDE	B9h	1s-0-0	4s-0-0	-	-	-	150MHz
Exit Deep Power Down	DPDX	ABh	1s-0-0	4s-0-0	-	-	-	150MHz
Software Reset Enable	SRTE	66h	1s-0-0	4s-0-0	-	-	-	150MHz
Software Reset	SRST	99h	1s-0-0	4s-0-0	-	-	-	150MHz
Read Register Instructions								
Read Status Register	RDSR	05h	1s-0-1s	4s-0-4s	-	-	1	150MHz
Read Configuration Register 1	RDC1	35h	1s-0-1s	4s-0-4s	-	-	1	150MHz
Read Configuration Register 2	RDC2	3Fh	1s-0-1s	4s-0-4s	-	-	1	150MHz
Read Configuration Register 3	RDC3	44h	1s-0-1s	4s-0-4s	-	-	1	150MHz
Read Configuration Register 4	RDC4	45h	1s-0-1s	4s-0-4s	-	-	1	150MHz
Read Configuration Register 1-4	RDCX	46h	1s-0-1s	4s-0-4s	-	-	4	150MHz
Read Device ID	RDID	9Fh	1s-0-1s	4s-0-4s	-	-	4	150MHz
Read Unique ID	RUID	4Ch	1s-0-1s	4s-0-4s	-	-	8	54MHz
Read Serial Number Register	RDSN	C3h	1s-0-1s	4s-0-4s	-	-	8	150MHz
Read Augmented 512-byte Protection Register	RDAP	14h	1s-0-1s	4s-0-4s	-	-	1	150MHz
Read Any Register - Address Based	RDAR	65h	1s-1s-1s	4s-4s-4s		0	1,4,8	150MHz
Write Register Instructions								
Write Status Register	WRSR	01h	1s-0-1s	4s-0-4s	-	-	1	150MHz
Write Configuration Registers 1-4	WRCX	87h	1s-0-1s	4s-0-4s	-	-	4	150MHz
Write Serial Number Register	WRSN	C2h	1s-0-1s	4s-0-4s	-	-	8	150MHz
Write Augmented 512-byte Protection Register	WRAP	1Ah	1s-0-1s	4s-0-4s	-	-	1	150MHz
Write Any Register - Address Based	WRAR	71h	1s-1s-1s	4s-4s-4s	-	-	1,8	150MHz

Instruction Command Set		Code	Command-Address-Data					Max. Frequency
Command	Name		Extended SPI	Quad SPI	XIP	Latency Cycles	Data Bytes	
Read Memory Instructions								
Read Memory - SDR	READ	03h	1s-1s-1s	-	-	-	1→∞	54MHz
Fast Read Memory - SDR	RDFT	0Bh	1s-1s-1s	4s-4s-4s	0	0	1→∞	150MHz
Fast Read Memory - DDR	DRFR	0Dh	1d-1d-1d	4s-4d-4d	0	0	1→∞	75MHz
Read Quad Output Memory - SDR	RDQO	6Bh	1s-1s-4s ⁽⁶⁾	4s-4s-4s	0	0	1→∞	150MHz
Read Quad Output Memory - DDR	DRQO	6Dh	1s-1d-4d ⁽⁶⁾	4s-4d-4d	0	0	1→∞	75MHz
Read Quad IO Memory - SDR	RDQI	EBh	1s-4s-4s ⁽⁶⁾	4s-4s-4s	0	0	1→∞	150MHz
Read Quad IO Memory - DDR	DRQI	EDh	1s-4d-4d	4s-4d-4d	0	0	1→∞	75MHz
Write Memory Instructions								
Write Memory - SDR	WRTE	02h	1s-1s-1s	4s-4s-4s	-	-	1→∞	150MHz
Fast Write Memory - SDR	WRFT	DAh	1s-1s-1s	4s-4s-4s	0	-	1→∞	150MHz
Fast Write Memory - DDR	DRFW	DEh	1s-1d-1d	4s-4d-4d	0	-	1→∞	75MHz
Write Quad Input Memory - SDR	WQDI	32h	1s-1s-4s ⁽⁶⁾	4s-4s-4s	0	-	1→∞	150MHz
Write Quad Input Memory - DDR	DWQI	31h	1s-1d-4d ⁽⁶⁾	4s-4d-4d	0	-	1→∞	75MHz
Write Quad IO Memory - SDR	WQIO	D2h	1s-4s-4s ⁽⁶⁾	4s-4s-4s	0	-	1→∞	150MHz
Write Quad IO Memory - DDR	DWQO	D1h	1s-4d-4d	4s-4d-4d	0	-	1→∞	75MHz
Read/Write Augmented 512-Byte Area Instructions								
Read Augmented Area	RDAS	4Bh	1s-1s-1s	-	-	0	1→512	150MHz
Write Augmented Area	WRAS	42h	1s-1s-1s	-	-	-	1→512	150MHz

Notes:

- Cs-A(s/d)-D(s/d) format: C stands for Command input, A stands for Address input, D stands for either Data input or Output, 's' stands for SDR, 'd' stands for DDR.
 '0' in Cs-A(s/d)-D(s/d) format indicates that no byte is required.
 '-' indicates 'not supported' or 'not required'.
- Extended SPI mode is enabled after power-on, software reset or JEDEC reset.
- Read Register operations do not wrap data. Reading beyond the specified number of bytes will yield indeterminate data.
- Write Enable (WREN) should be implemented in advance of Write Register Instruction set regardless of CR4[1:0] setting.
 The WREN prerequisite for write operation of memory and augmented area is described in Configuration Register 4.
- Latency is configurable through Configuration Register 2 (CR2[3:0]) and frequency dependent.
 Required latency is described in Configuration Register 2.
- The frequency of 1s-1s-4s and 1s-4s-4s is limited to 108MHz.
 The frequency of 1s-1d-4d is limited to 54MHz.

7.2 RESET Operations

The device supports the software reset and JEDEC reset functions. The device may be reset in software by the Reset Enable and Software Reset instructions or JEDEC reset. Extended SPI mode is enabled after software reset or JEDEC reset.

7.2.1 Software Reset

To reset the device in software, the Reset Enable command is issued, followed by the Software Reset command. The device then enters a power-on reset condition. The CS# High time (t_{SRST}) must be observed between commands.

Figure 7: Software Reset Timing

Extended SPI

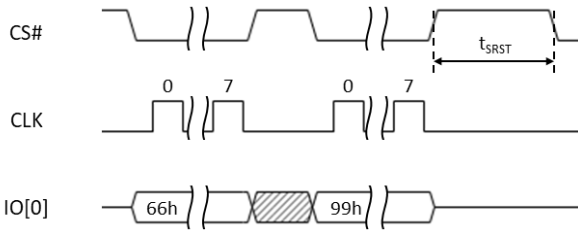

Quad SPI

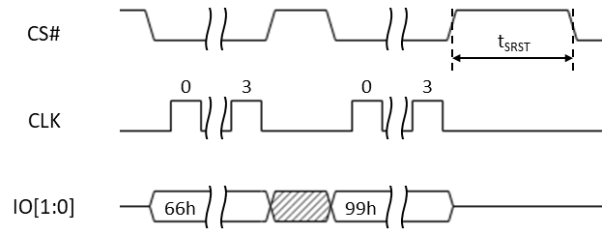

7.2.2 JEDEC Reset

Figure 8: JEDEC Reset Timing

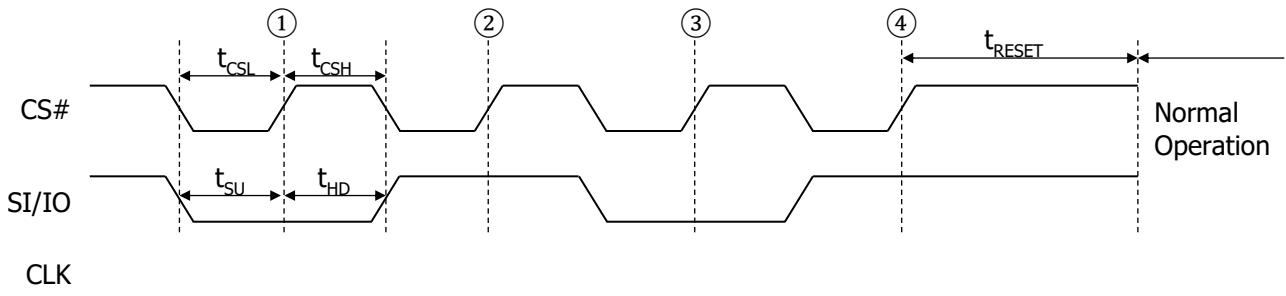

Table 22: JEDEC Reset Timing

Parameter	Symbol	Min.	Max.	Units
CS# Low Time	t_{CSL}	0.5	-	μs
CS# High Time	t_{CSH}	0.5	-	μs
SI/IO[0] Setup Time (w.r.t CS#)	t_{SU}	5.0	-	ns
SI/IO[0] Hold Time (w.r.t CS#)	t_{HD}	5.0	-	ns
JEDEC Hardware Reset	t_{RESET}	-	2.0	ms

7.3 WRITE ENABLE/DISABLE Operations

To initiate a command for each die, CS# must be driven Low and held Low until the eighth bit of the command code is latched in, then driven High. For Extended SPI and Quad SPI protocols respectively, the command code is input on IO[0] and IO[3:0].

A Write Enable command (WREN) is needed to set the WREN bit prior to Write Register Instruction regardless of CR4[1:0] setting.

The WREN prerequisite for write operation of memory and augmented area is described in Configuration Register 4.

Figure 9: WRITE Enable/Disable Timing

WRITE ENABLE (06h)

WRITE DISABLE (04h)

Extended SPI

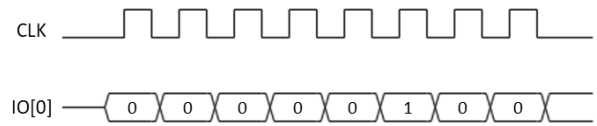
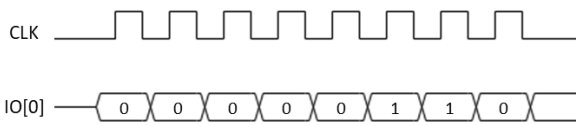

Quad SPI

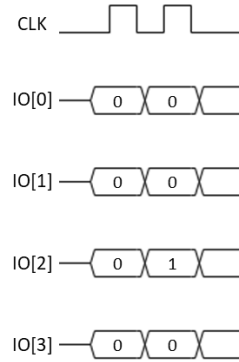
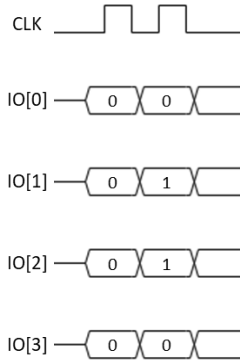

7.4 Enable Extended, Quad SPI mode and No Operation

To initiate a command for each die, CS# is driven Low and held Low until the eighth bit of the command code is latched in, then driven High. For Extended SPI and Quad SPI protocols respectively, the command code is input on IO[0] and IO[3:0]. When Quad SPI is enabled, CR2[6] bit of the Configuration Register 2 is set to '1', otherwise, CR2[6] bit is reset to '0'.

Figure 10: Enable Extended SPI or Quad SPI mode

Extended SPI → Quad SPI

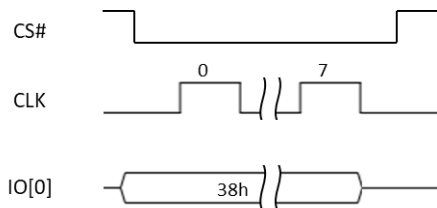

Quad SPI → Extended SPI

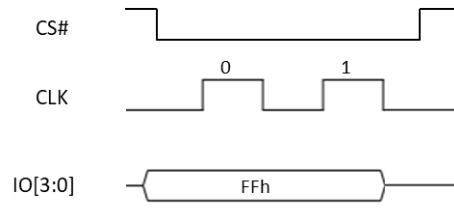

If a no-operation command (00h) is entered, the device will not perform any action. For example, in the S3H6408R1M device, if you want to operate only one of the two dies, enter the 00h command to the other die.

Figure 11: No operation

Extended SPI

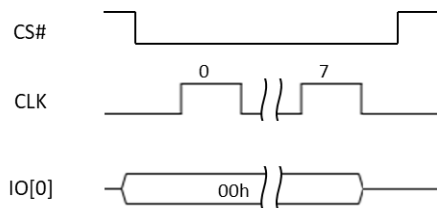

Quad SPI

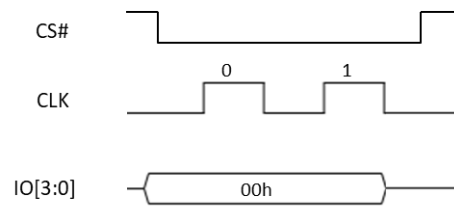

7.5 Register Operation

7.5.1. Read Register Operations

To initiate register read operations, CS# is driven Low and the command code is input, followed by input of the address bytes if required. The operation is terminated by driving CS# High, and the output goes to High-Z.

Figure 12: Read Status Register Timing

Extended SPI

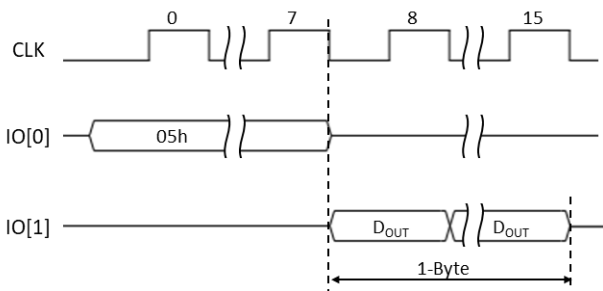

Quad SPI

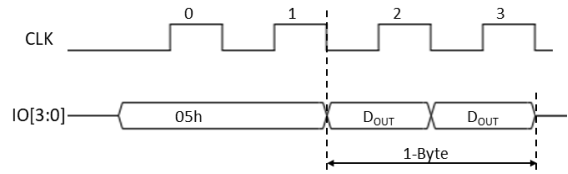
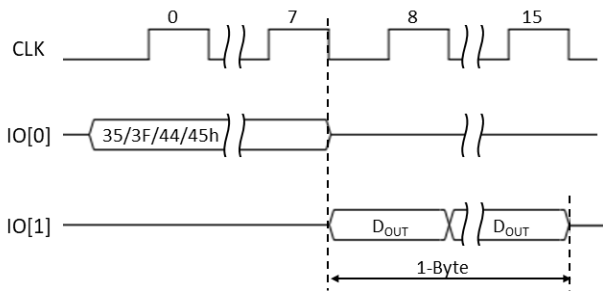

Figure 13: Read Configuration Register 1, 2, 3 or 4 Timing

Extended SPI



Quad SPI

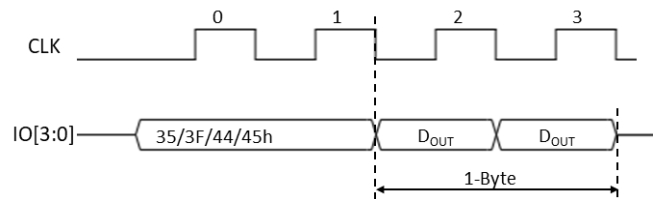
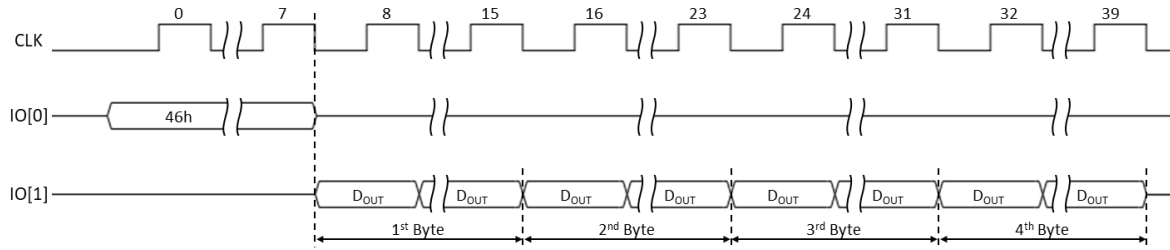
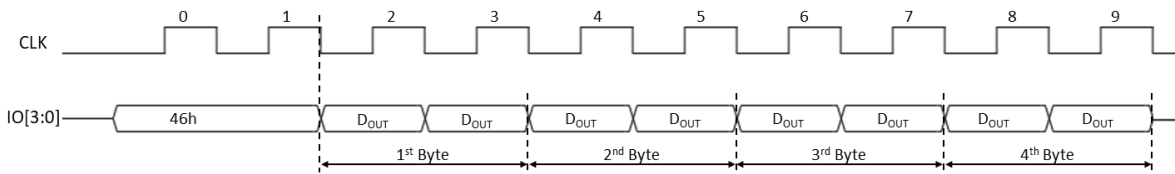

Figure 14: Read Configuration Register 1-4 Timing

Extended SPI



Quad SPI



Notes:

1. 1st Byte: CR1[7:0], 2nd Byte: CR2[7:0], 3rd Byte: CR3[7:0], 4th Byte: CR4[7:0],

Figure 15: Read Device ID Timing

Extended SPI

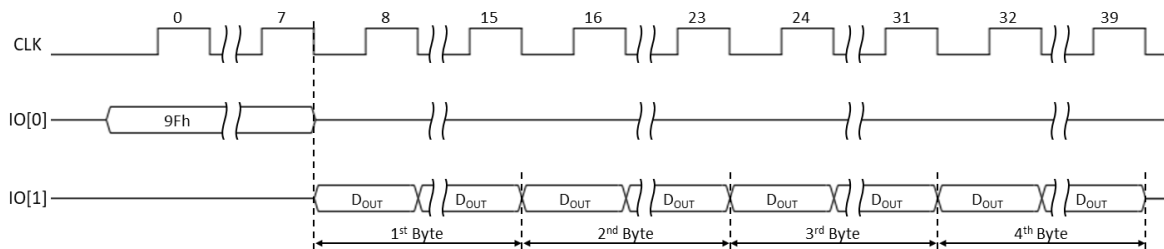

Quad SPI

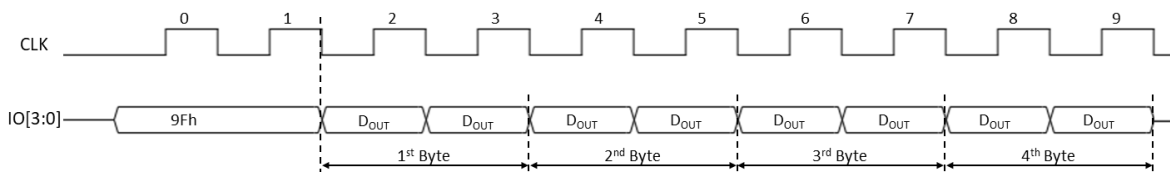
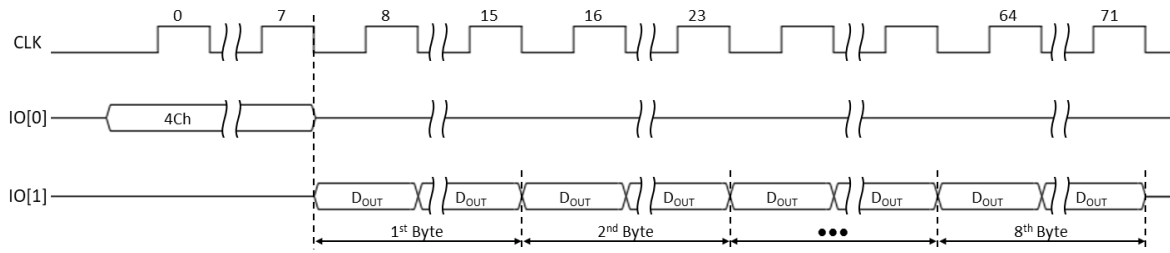

Figure 16: Read Unique ID Timing

Extended SPI



Quad SPI

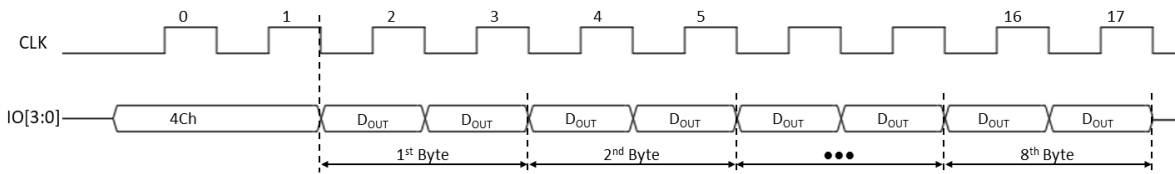
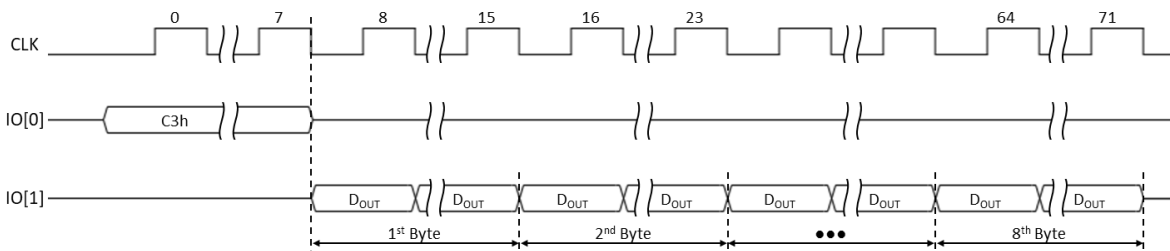

Figure 17: Read Serial Number Register Timing

Extended SPI



Quad SPI

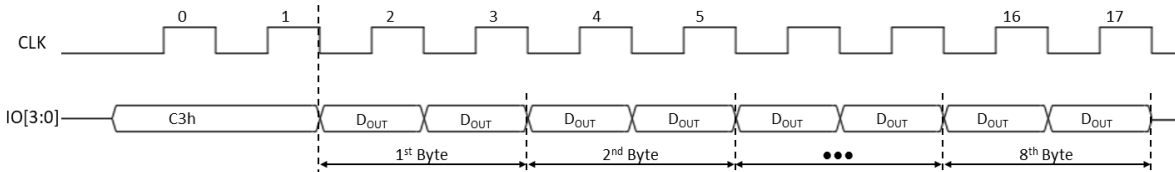
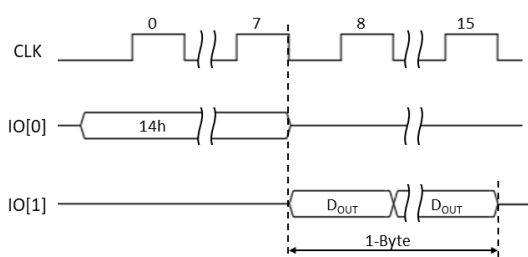

Figure 18: Read Augmented 512-byte Protection Register Timing

Extended SPI



Quad SPI

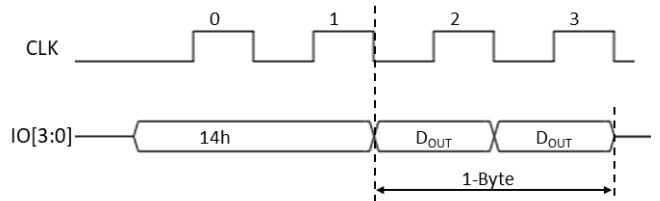
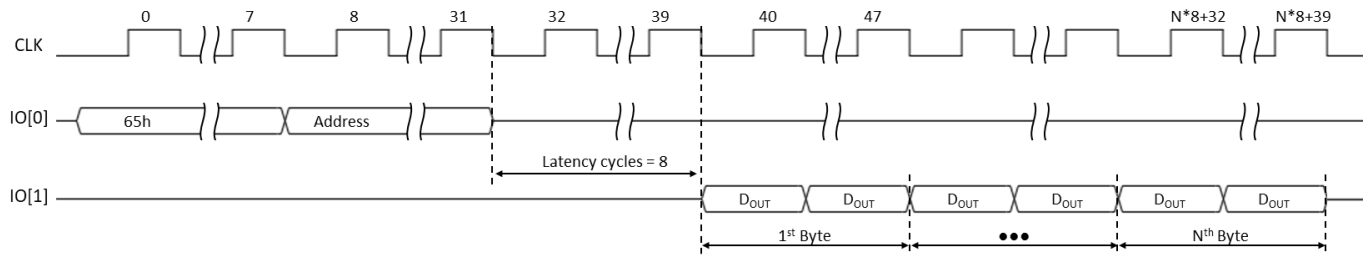
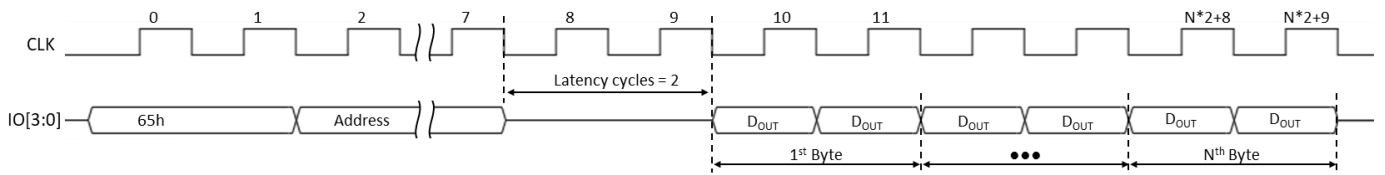

Figure 19: Read Any Register Timing

Extended SPI



Quad SPI



Notes:

1. The latency cycles of Read Any Register instruction (65h) are 8 in Extended SPI or 2 in Quad SPI, regardless of Read latency Selection Bits CR2[3:0].
2. N can be 1, 4, or 8. See the table 6: Register Address Map.

7.5.2. WRITE REGISTER Operations

Before a Write Register command is initiated, Status Register or Configuration Register should be set Writable (See Table 7: Write Protection Modes).

To initiate register write operations, CS# is driven Low and the command code is input, followed by input of the address bytes if required, and followed by the input data. The operation is terminated by driving CS# High.

Figure 20: Write Status Register Timing

Extended SPI

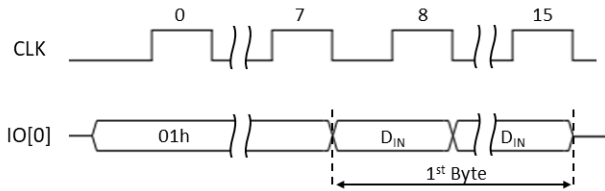

Quad SPI

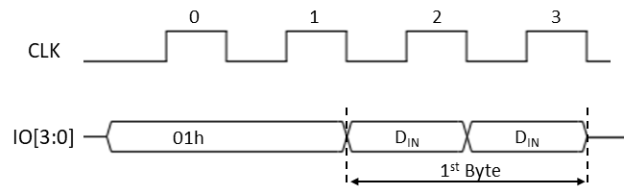
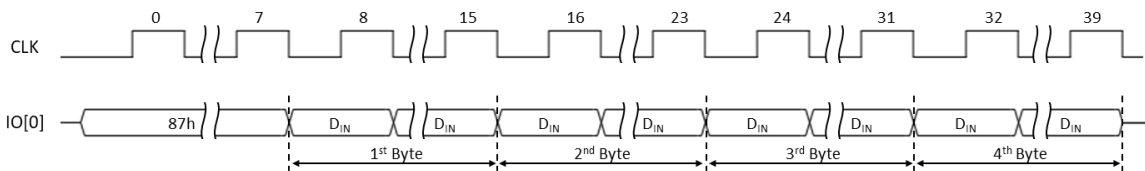
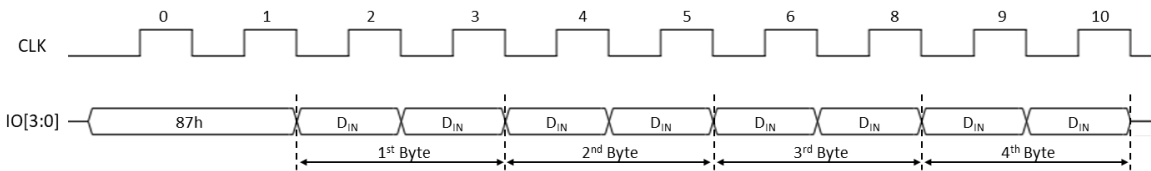

Figure 21: Write Configuration Register 1-4 Timing

Extended SPI



Quad SPI



Notes:

- 1st Byte: CR1[7:0], 2nd Byte: CR2[7:0], 3rd Byte: CR3[7:0], 4th Byte: CR4[7:0],

Figure 22: Write Serial Number Register Timing

Extended SPI

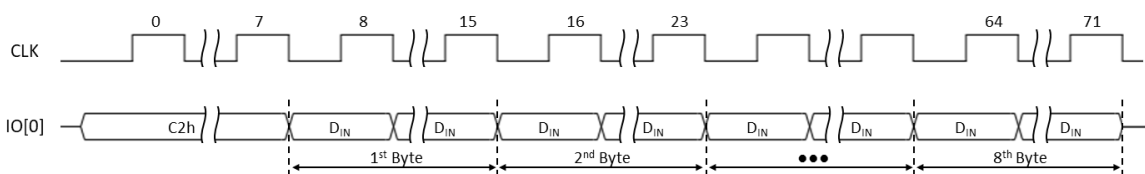

Quad SPI

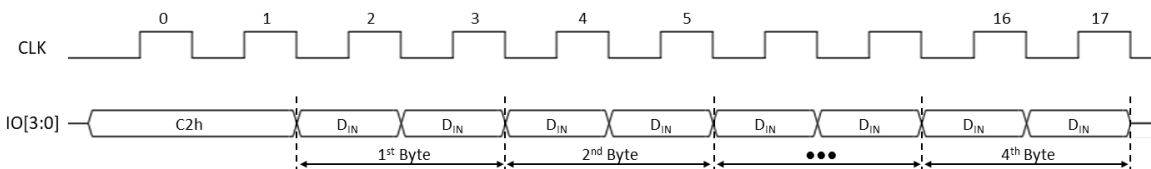
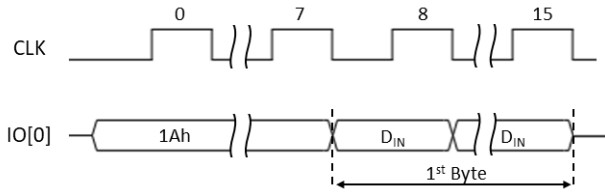

Figure 23: Write Augmented 512-byte Protection Register Timing

Extended SPI



Quad SPI

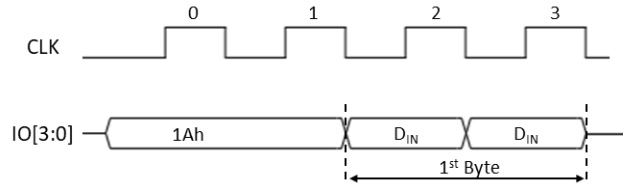
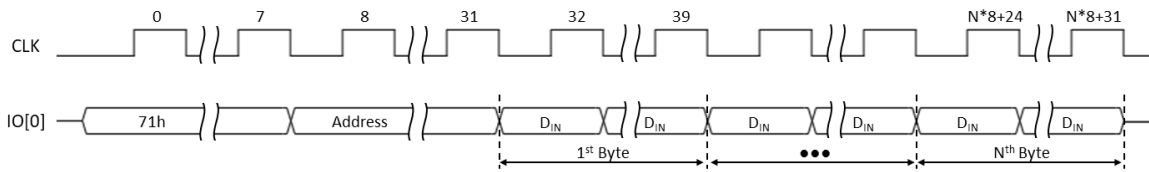
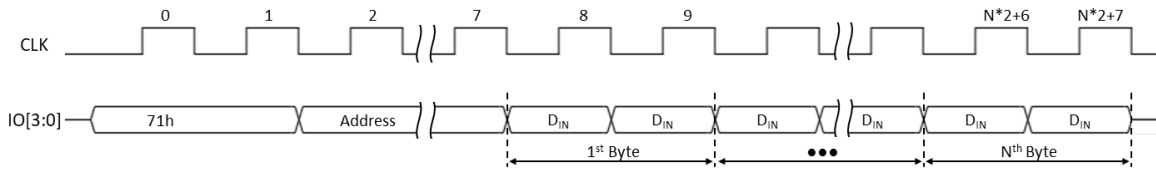

Figure 24: Write Any Register Timing

Extended SPI



Quad SPI



Notes:

1. N can be 1 or 8 depending on the address. See the table 5 - Register Address Map.

7.6 Memory Operation

To initiate memory read operation, CS# is driven Low and the command code is input, followed by input of the address bytes. The operation is terminated by driving CS# High at any time during data output.

7.6.1 READ MEMORY Operations

Figure 25: Read Memory Timing

1) 1s-1s-1s transaction

Extended SPI: Read Memory (03h)

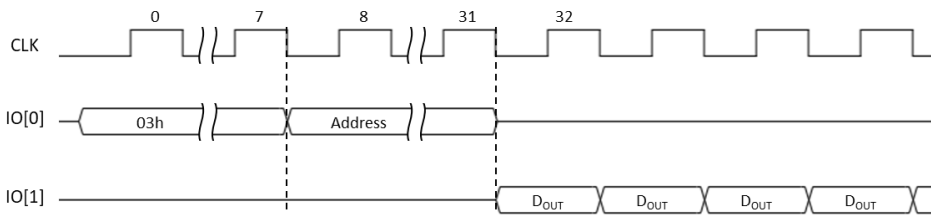

2) 1s-1s-1s transaction

Extended SPI: Fast Read Memory (0Bh)

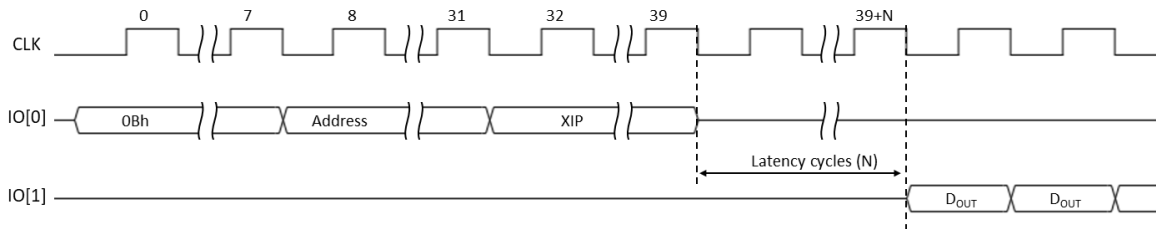

3) 1s-1s-4s transaction

Extended SPI: Read Quad Output Memory (6Bh)

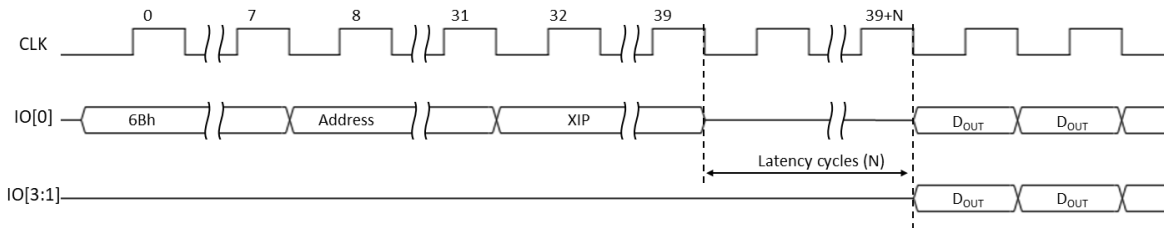

4) 1s-4s-4s transaction

Extended SPI: Read Quad IO Memory (EBh)

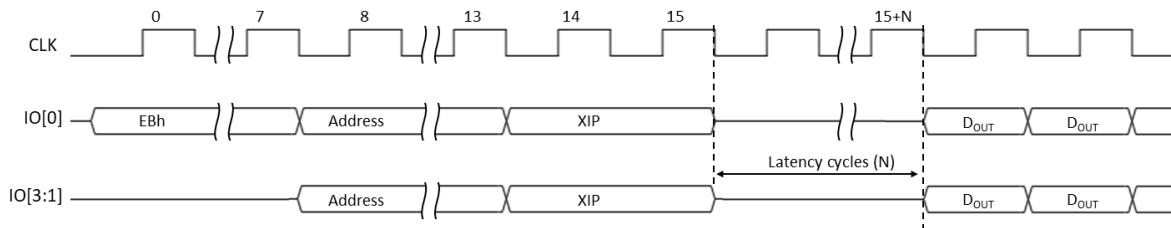

5) 4s-4s-4s transaction

Quad SPI: Fast Read Memory (0Bh), Read Quad Output Memory (6Bh), Read Quad I/O Memory (EBh)

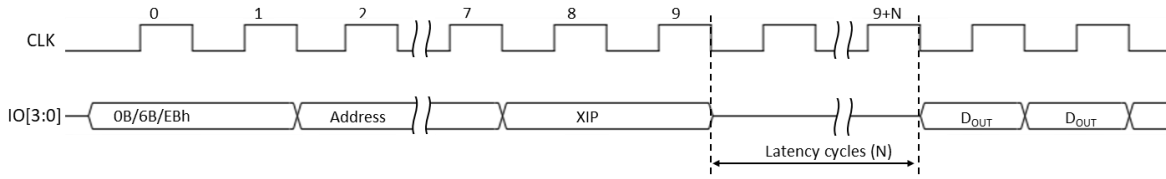

6) 1s-1d-1d transaction

Extended SPI: Fast Read Memory-DDR (0Dh)

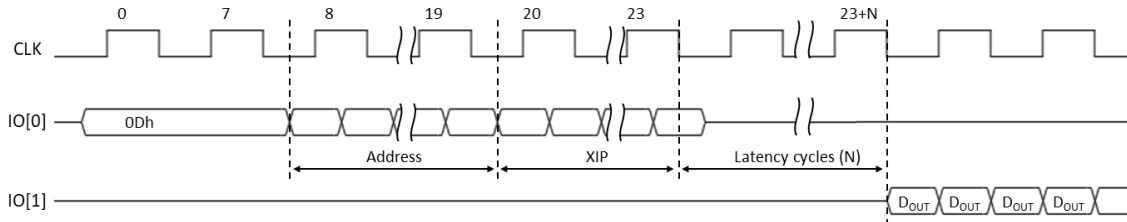

7) 1s-1d-4d transaction

Extended SPI: Read Quad Output Memory-DDR (6Dh)

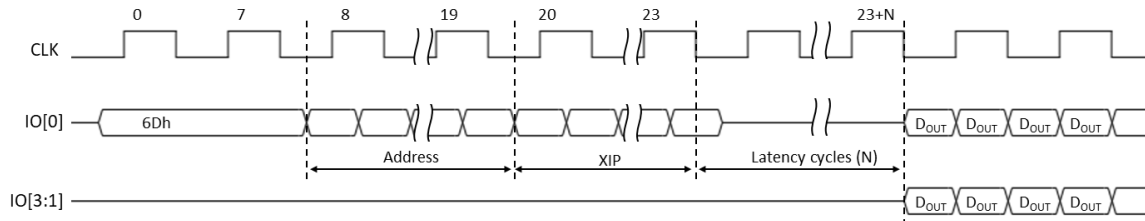

8) 1s-4d-4d transaction

Extended SPI: Read Quad IO Memory-DDR (EDh)

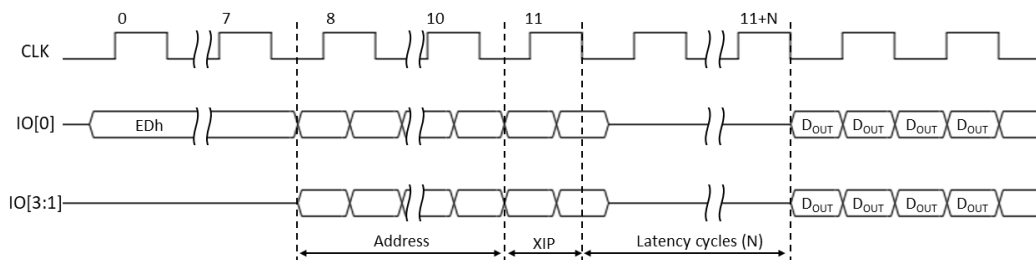

9) 4s-4d-4d transaction

QUAD SPI: Fast Read Memory-DDR (0Dh), Read Quad Output Memory-DDR (6Dh), Read Quad IO Memory-DDR (EDh)

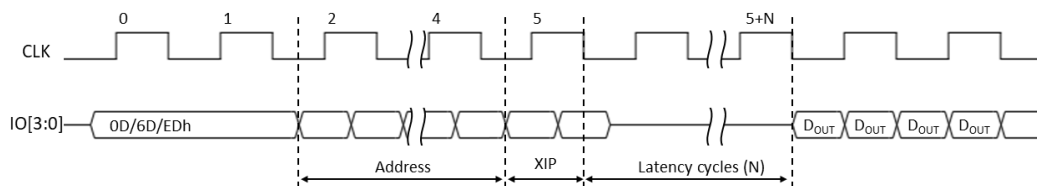

7.6.2 Write Memory Operations

To initiate memory write operation, CS# is driven Low and the command code is input, followed by input of the address and data. The operation is terminated by driving CS# High at any time during data input. The WREN prerequisite for write operation of memory is described in Configuration Register 4.

Figure 26: Write Memory Timing

1) 1s-1s-1s transaction

Extended SPI: Write Memory (02h)

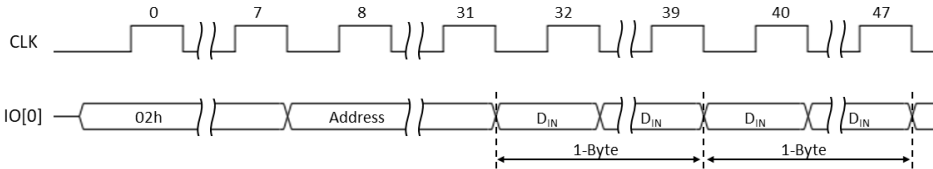

2) 4s-4s-4s transaction

Quad SPI: Write Memory (02h)

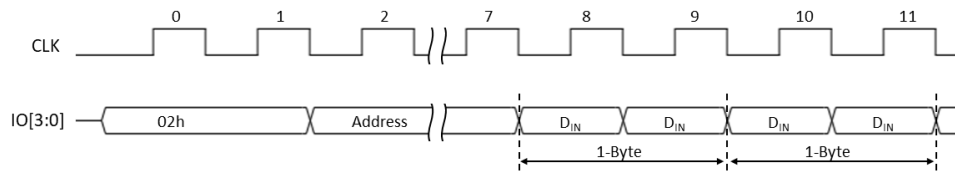

3) 1s-1s-1s transaction with XIP

Extended SPI: Fast Write Memory (DAh)

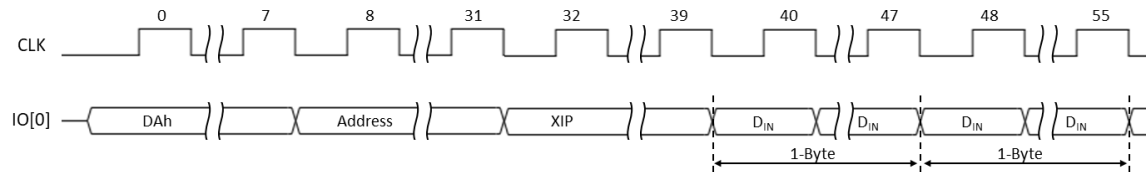

4) 1s-1s-4s transaction with XIP

Extended SPI: Write Quad Input Memory (32h)

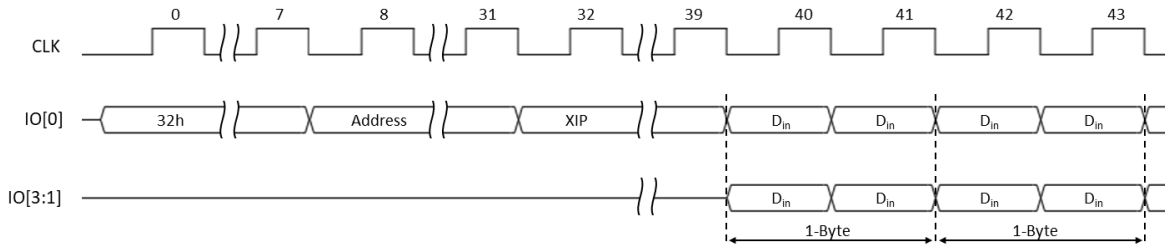

5) 1s-4s-4s transaction with XIP

Extended SPI: Write Quad IO Memory (D2h)

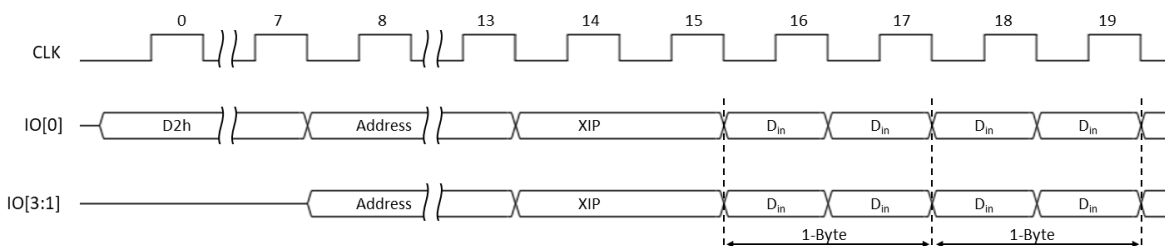

6) 4s-4s-4s transaction with XIP

Quad SPI: Fast Write Memory (DAh), Write Quad Input Memory (32h), Write Quad IO Memory (D2h)

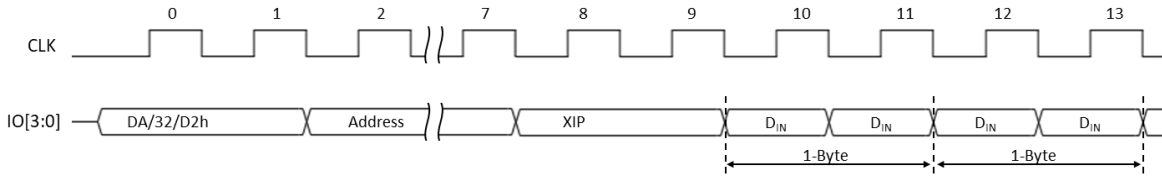

7) 1s-1d-1d transaction with XIP

Extended SPI: Fast Write Memory -DDR (DEh)

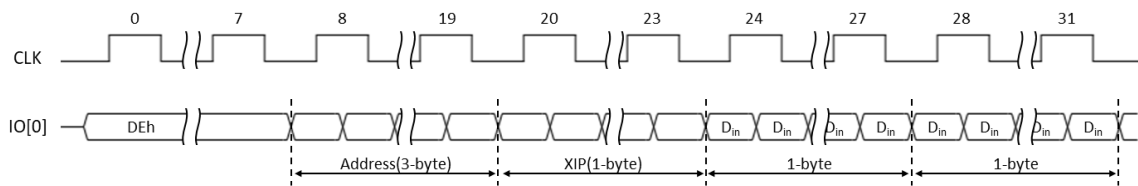

8) 1s-1d-4d transaction with XIP

Extended SPI: Write Quad Input Memory -DDR (31h)

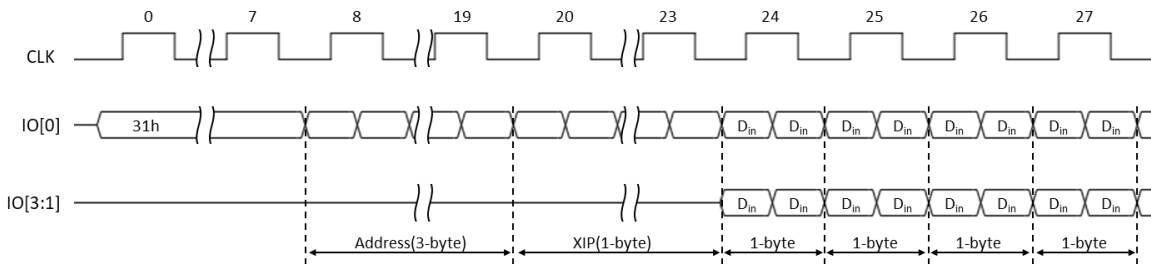

9) 1s-4d-4d transaction with XIP

Extended SPI: Write Quad IO Memory -DDR (D1h)

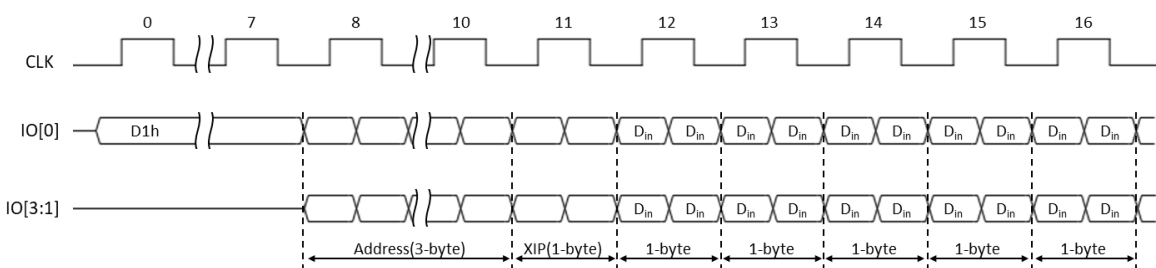

10) 4s-4d-4d transaction with XIP

Quad SPI: Fast Write Memory -DDR(DEh), Write Quad Input Memory -DDR(31h), Write Quad IO Memory -DDR (D1h)

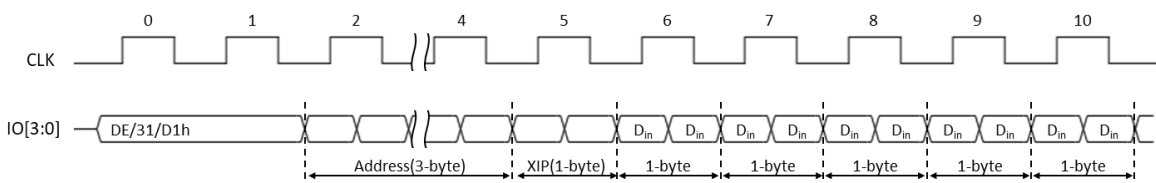

7.6.3 XIP Operations

The device offers XIP (execute in place) mode for both read and write operations.

XIP allows a series of read or write operation without loading individual read or write command for each instruction, which results in reduced random access time. XIP is enabled by entering byte AXh and disabled by entering any byte not equal to AXh (X=Don't Care). These respective bytes must be entered following the address bits. Read operation with XIP needs extra read latency cycles before data output. The read latency cycles are specified in Table 12.

Figure 27: Read XIP Timing

1) 1s-1s-1s transaction, Extended SPI, Read operation

- Enabling XIP

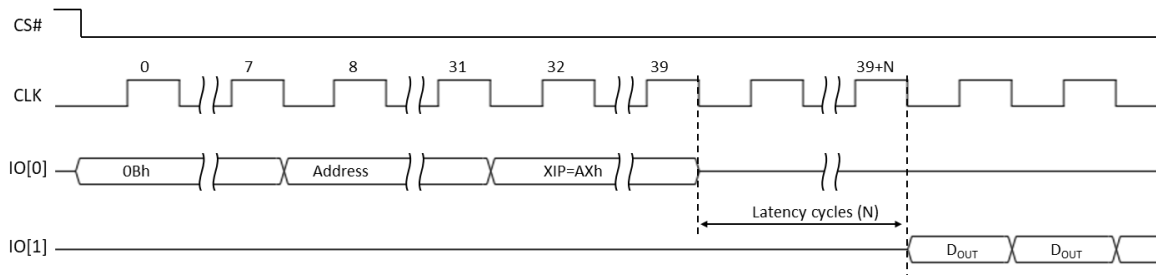

- Continuous XIP

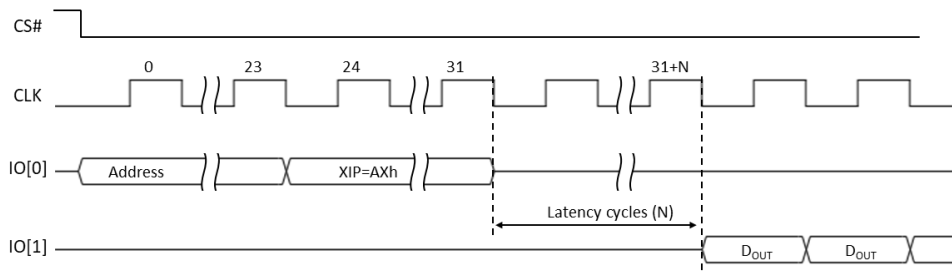

- Terminating XIP

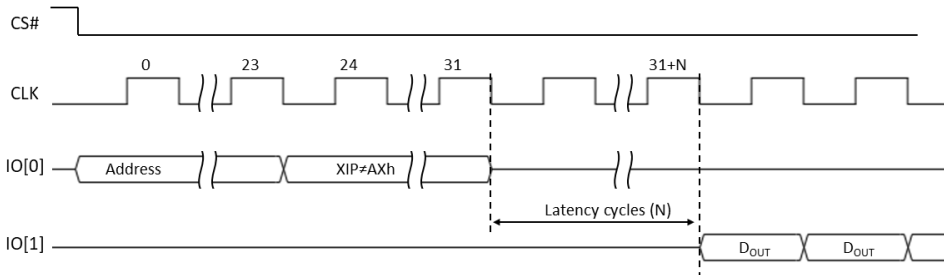

2) 4s-4s-4s transaction, Quad SPI, Read operation

- Enabling XIP

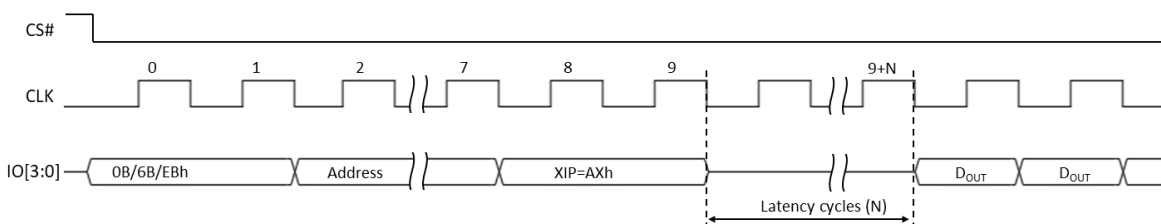

- Continuous XIP

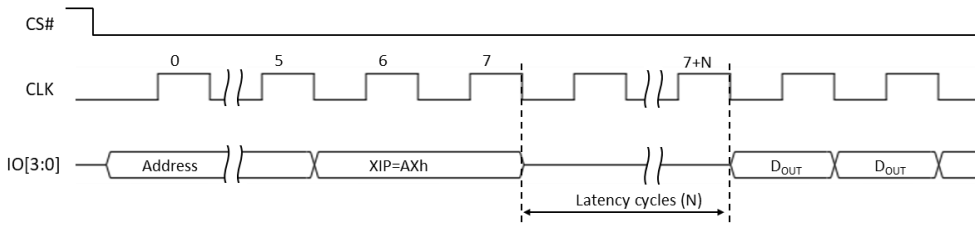

- Terminating XIP

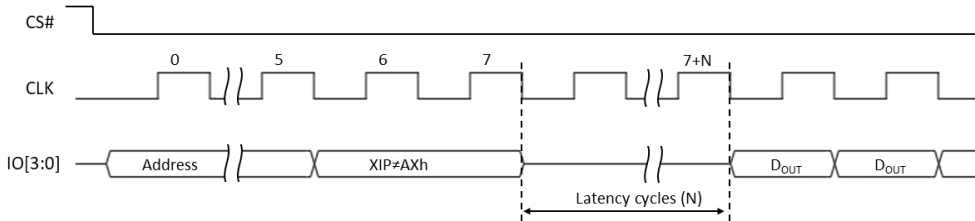

3)4s-4d-4d transaction, Quad SPI, Read operation

- Enabling XIP

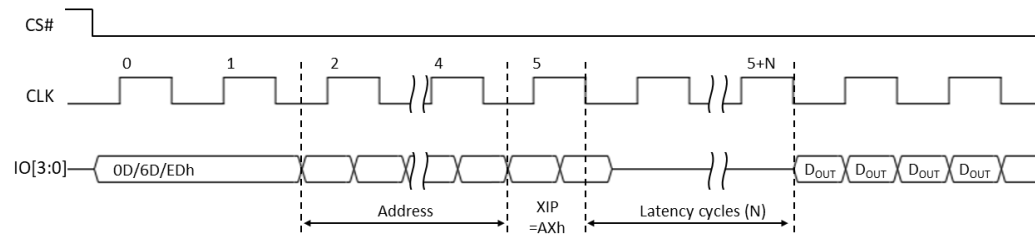

- Continuous XIP

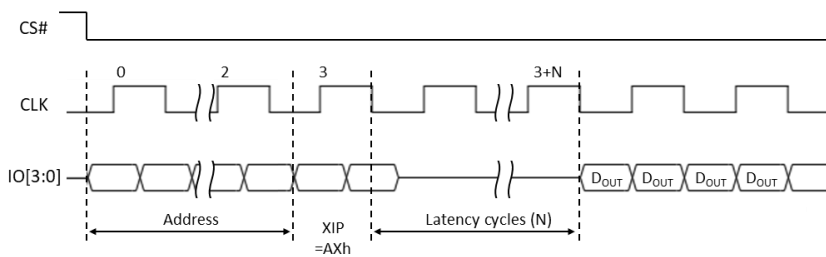

- Terminating XIP

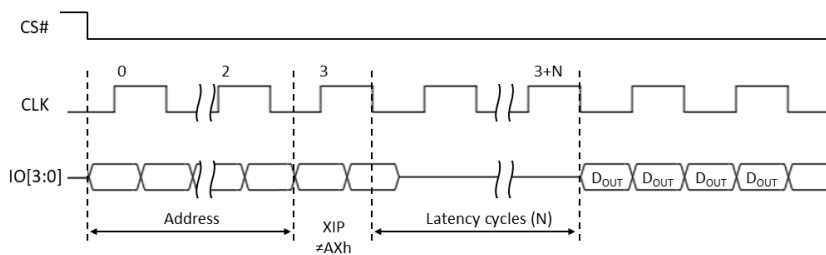

Other transactions or Write XIP operations are similar.

7.7 Augmented Area Operation

To initiate read operation for augmented area, CS# is driven Low and the command code is input, followed by input of the address bytes. The operation is terminated by driving CS# High at any time during data output.

Figure 28: Read Augmented 512-byte Area Timing

1s-1s-1s transaction

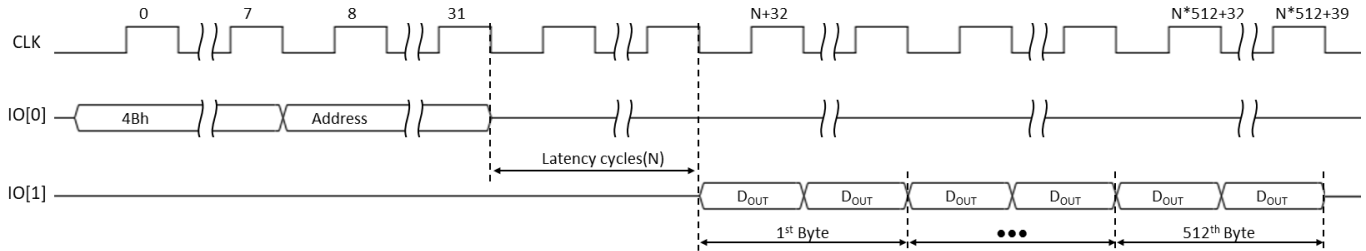

Notes:

1. Latency cycles for Read Augmented 512-byte Area are configurable through Configuration Register 2 (CR2[3:0]).

To initiate write operation for augmented area, CS# is driven Low and the command code is input, followed by input of the address and data. The operation is terminated by driving CS# High at any time during data input. The WREN prerequisite for write operation of augmented area is described in Configuration Register 4.

Figure 29: Write Augmented 512-byte Area Timing

1s-1s-1s transaction

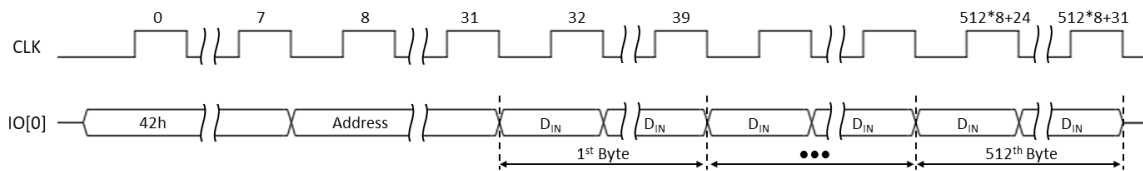

7.8 Deep Power-down Operation

The device provides Deep Power Down mode. This mode reduces current consumption from I_{SB} to I_{DPD} . To enter the deep power down mode, CS# is driven Low, followed by Enter Deep Power Down (B9h) command, CS# is driven High after the eighth bit of the command code has been latched in.

After CS# is driven High, it requires a delay of t_{EDPD} before the supply current is reduced to I_{DPD} and the Deep Power Down mode is entered. The command can be issued in Extended SPI or Quad SPI modes.

Deep Power-down Enter

Extended SPI

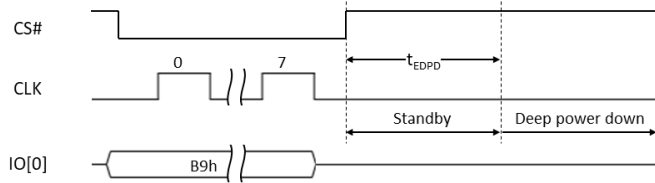

Quad SPI

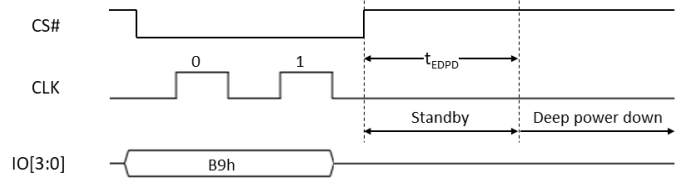

There are two ways to exit deep power down mode:

1. Driving CS# Low is followed with Exit Deep Power Down (ABh) command. CS# must be driven High after the eighth bit of the command code is latched in.
2. Toggling CS# with a pulse width of t_{CSDPD} while CLK and I/Os are Don't Care state. During waking up from deep power down, I/Os remain to be in High-Z.

Deep Power-down Exit

Extended SPI

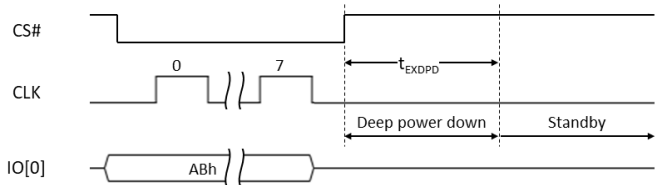

Quad SPI

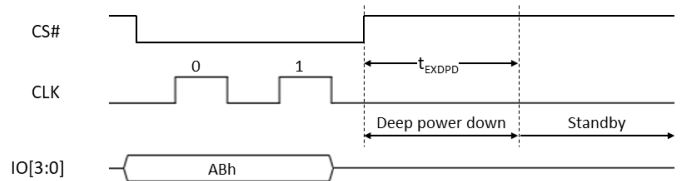

Toggling CS#

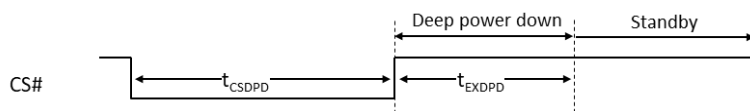

It requires a delay of t_{EXDPD} before the device can fully exit the deep power down mode and enter standby mode. Status of all non-volatile bits in registers and operation mode (Extended or Quad SPI mode) remains unchanged when the device enters or exits the deep power down mode. The command can be issued in Extended SPI or Quad SPI mode.

8. Electrical Specifications

8.1 Absolute Maximum Ratings

Stresses greater than those listed may cause permanent damage to the device. This is a stress rating only. Exposure to maximum rating for extended periods may adversely affect reliability.

Table 23: Absolute Maximum Ratings

Parameter	Min.	Max.	Units
Voltage on Vcc Supply Relative to VSS	-0.5	2.35	V
Voltage on Any Pin relative to VSS	-0.5	2.35	V
Storage Temperature	-55	150	°C
Operating Ambient Temperature	-40	85	°C
ESD HBM (Human Body Model)	≥ 2000 V		V
ESD CDM (Charged Device Model)	≥ 500 V		V
Package Process Condition	JEDEC J-STD-020 reflow profiles - Peak temperature ≤ 260°C - The time above 255°C ≤ 30 seconds - Reflow cycles ≤ 3 times		

8.2 Endurance, Retention and Magnetic Immunity

Table 24: Write Endurance, Retention and Magnetic Immunity

Parameter	Conditions	Min.	Max.	Units
Write Endurance	-25°C	10 ¹⁴	-	cycles
Data Retention	85°C	10	-	years
Magnetic Field During Write or Read	-	-	24,000	A/m

8.3 Recommended Operating Conditions

Table 25: Recommended Operating Conditions

Parameter / Condition		Min.	Typ.	Max.	Units
Operating Temperature	Industrial	-40	25	85	°C
Vcc Supply Voltage		1.71	1.8	1.98	V
Vss Supply Voltage		0.0	0.0	0.0	V

8.4 Pin Capacitance

Table 26: Pin Capacitance

Parameter	Conditions	Typ.	Max.	Units
Input Pin Capacitance	TEMP = 25°C; f = 1 MHz; V _{IN} = 0V	-	6	pF
Input/Output Pin Capacitance	TEMP = 25°C; f = 1 MHz; V _{I/O} = 0V	-	10	pF

Notes:

1. Capacitance is sampled and not 100% tested

8.5 AC Test Condition

Table 27: AC Test Conditions

Parameter	Value
Input pulse levels	0.0V to Vcc
Input rise and fall times	1ns/1V
Input and output measurement timing levels	Vcc/2
Output Load	C _{Load} = 12pF

8.6 DC Characteristics

Table 28: DC Characteristics

Parameter	Symbol	Test Conditions	1.71V~1.98V			Units
			Min.	Typ.	Max.	
Input Leakage Current	I_{LI}	$V_{IN} = 0$ to V_{CC} (max)	-2	-	2	μA
Output Leakage Current	I_{LO}	$V_{OUT} = 0$ to V_{CC} (max)	-2	-	2	μA
Read Current (1-1-1)	I_{CCR}	SDR=133MHz, DDR=66MHz CS# or CS1# and CS2# =0, $I_{OUT}=0mA$	-	9	13	mA
Read Current (4-4-4)	I_{CCR}		-	16	24	mA
Read Current (1-1-1)	I_{CCR}	SDR=150MHz, DDR=75MHz CS# or CS1# and CS2# =0, $I_{OUT}=0mA$	-	11	17	mA
Read Current (4-4-4)	I_{CCR}		-	18	27	mA
Write Current (1-1-1)	I_{CCW}	SDR=133MHz, DDR=66MHz CS# or CS1# and CS2# =0, $I_{OUT}=0mA$	-	15	20	mA
Write Current (4-4-4)	I_{CCW}		-	43	56	mA
Write Current (1-1-1)	I_{CCW}	SDR=150MHz, DDR=75MHz CS# or CS1# and CS2# =0, $I_{OUT}=0mA$	-	16	21	mA
Write Current (4-4-4)	I_{CCW}		-	48	63	mA
Standby Current	I_{SB}	CLK=0 or CLK1 and CLK2=0 CS# or CS1# and CS#=Vcc, $I/O=0/V_{CC}$	-	1.2	1.8	mA
Deep Power Down Current	I_{DPD}	CLK=0 or CLK1 and CLK2=0 CS# or CS1# and CS#=Vcc, $I/O=0/V_{CC}$	-	120	580	μA
Input High Voltage	V_{IH}	-	$0.7 \times V_{CC}$	-	$V_{CC}+0.3$	V
Input Low Voltage	V_{IL}	-	-0.3	-	$0.3 \times V_{CC}$	V
Output High Voltage Level	V_{OH}	$I_{OH} = -1mA$	1.4	-	-	V
Output Low Voltage Level	V_{OL}	$I_{OL} = 2mA$	-	-	0.4	V

8.7 AC Timing Characteristics

8.7.1 Synchronous Input Timing

Figure 30: Synchronous Input Timing (SDR/DDR)

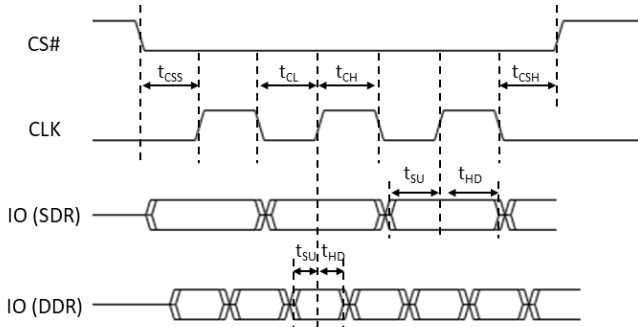

8.7.2 Synchronous Output Timing

Figure 31: Synchronous Data Output Timing (SDR/DDR)

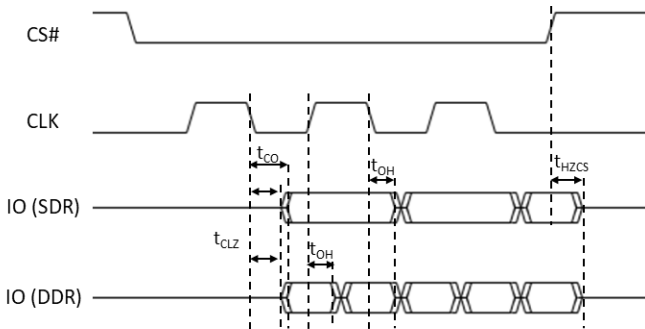

8.7.3 WP# Timing

Figure 32: WP# Operation Timing

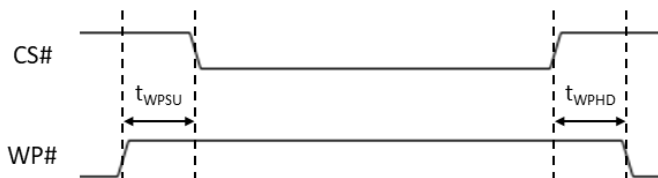

8.7.4 CS# High Time

CS# High time (the period during which CS# signal remains High) is divided into five timing based on operations.

- 1) CS# High time after any Read instructions, Write Enable/Disable, Enable Quad SPI/Extended SPI, No Operation and Software Reset Enable.
- 2) CS# High time after Write Memory instructions.
- 3) CS# High time after Write Register instructions or Augmented Area instruction.
- 4) CS# High time to deep power down exit.
- 5) CS# High time after JEDEC reset and software reset operation.

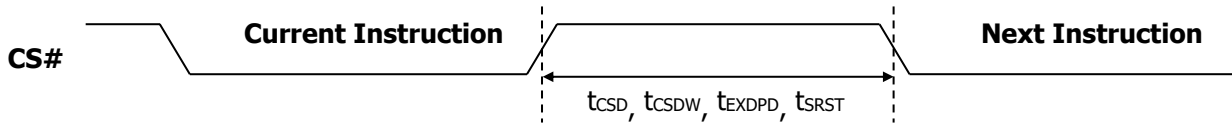

Table 29: CS# High time after instructions

Parameter	Symbol	Min	Max.	Unit
CS# High time after any Read instructions, Write Enable/Disable, Enable Quad/Dual/Extended SPI, No Operation and Software Reset Enable	t_{CSD}	20	-	ns
CS# High time after Write Memory instructions	t_{CSDW}	Refer to Table 31		-
CS# High time after Write Register instructions or Augmented Area instruction	t_{CSDW}	Refer to Table 32		-
CS# High time after deep power down exit command	t_{EXDPD}	25	-	us
CS# High time after JEDEC reset and software reset	t_{SRST}	2.0	-	ms

Notes:

1. Read Status Register (05h) instruction is applicable during any CS# High period.

8.7.5 AC Timing Parameters

Table 30: AC Timing Parameter

Parameter	Symbol	Min.	Max.	Units
Clock Frequency – SDR	f_{CLK}	1	150	MHz
Clock Frequency – DDR	f_{CLK}	1	75	MHz
Clock Low Time	t_{CL}	$0.45 * 1/ f_{CLK}$	-	ns
Clock High Time	t_{CH}	$0.45 * 1/ f_{CLK}$	-	ns
CS# Setup Time	t_{CSS}	5	-	ns
CS# Hold Time	t_{CSH}	4	-	ns
CS# High Time after Any Instruction (except Write)	t_{CSD}	20	-	ns
CS# High Time after Write Instruction	t_{CSDWX}	Refer to Table 31, 32		ns
Data Setup Time	t_{SU}	2	-	ns
Data Hold Time	t_{HD}	2	-	ns
CLK Low to Output Valid	t_{CO}	-	7.0	ns
CLK to Output Hold Time	t_{OH}	2.0	-	ns
CLK Low to Output Low-Z (Read)	t_{CLZ}	2.0	-	ns
CS# High to Output High-Z	t_{HZCS}	-	6.0	ns
WP# Setup Time	t_{WPSU}	20	-	ns
WP# Hold Time	t_{WPHD}	20	-	ns
CS# High to Power-down mode	t_{EDPD}	-	1	us
CS# High to Power-down mode exit	t_{EXDPD}	-	25	us
CS# Low time to exit Power-down mode	t_{CSDPD}	50	-	ns
JEDEC Reset or Software Reset Time	t_{SRST}	-	2.0	ms

Table 31: CS# High Time after Write Memory Instruction

Current Instruction : Write Memory	Next Instruction : Read or Write Memory	Symbol	Operating Frequency, SDR								Units	
			150	133	125	108	100	83	66	54		
1s-1s-1s	1s-1s-1s, 1s-1s-4s	t _{CSDW1}	20	20	20	20	20	20	20	20	20	ns
1s-1s-1s	1s-4s-4s	t _{CSDW2}	140	130	120	110	90	60	20	20	20	ns
1s-1s-4s, 1s-4s-4s	1s-1s-1s, 1s-1s-4s	t _{CSDW3}	110	70	40	20	20	20	20	20	20	ns
1s-1s-4s, 1s-4s-4s	1s-4s-4s	t _{CSDW4}	230	200	190	140	110	60	20	20	20	ns
4s-4s-4s	4s-4s-4s	t _{CSDW5}	270	250	230	200	170	140	110	80	20	ns

Current Instruction : Write Memory	Next Instruction : Read or Write Memory	Symbol	Operating Frequency, DDR							Units	
								75	66		54
1s-1d-1d	1s-1d-1d, 1s-1d-4d	t _{CSDW6}						20	20	20	ns
1d-1d-1d	1s-4d-4d	t _{CSDW7}						100	60	20	ns
1s-1d-4d, 1s-4d-4d	1s-1d-1d, 1s-1d-4d	t _{CSDW8}						90	20	20	ns
1s-1d-4d, 1s-4d-4d	1s-4d-4d	t _{CSDW9}						200	130	50	ns
4s-4d-4d	4s-4d-4d	t _{CSDW10}						270	220	160	ns

Notes:

1. The frequency for 1s-1s-4s and 1s-4s-4s mode is limited to 108MHz.
The frequency for 1s-1d-4d mode is limited to 54MHz.
2. The High CS# time after Write Memory instructions is strongly dependent on SPI mode and frequency.

Table 32: CS# High Time after Register/Augmented Area Write Instruction

Current Instruction	Next Instruction	Symbol	Min.	Units
Write Memory Instructions	Read Register except for Status Register Write Register Read or Write Augmented Area	t _{CSDW11}	500	ns
Write Register Instructions Write Augmented Area Instruction	Any Instructions except for Status Register	t _{CSDW12}	1000	ns

9. Thermal Resistance

Table 33: Thermal Resistance

Parameter	Description	24 BGA	Unit
θ_{JA}	Thermal resistance (junction to ambient)	69.2	°C/W
θ_{JC}	Thermal resistance (junction to case)	30.4	

Notes:

1: These parameters are guaranteed by characterization; not tested in production.

10. Part Numbering System

S	3	H	x	x	x	x	x	x	x	-	x	x	x	x	x	x	x
1	2	3	4	5	6	7	8	9	10	11	12	13	14	15	16	17	18

Netsol Memory: S

MRAM: 3

Interface
Dual-Quad SPI : H

Density
64Mb: 64

I/O Organization
x8: 08

VCC
1.71~1.98V: R

Mode
Dual Quad 1-CS#, 1-CLK: 1
Dual Quad 2-CS#, 2-CLK: 2

Special Code
by customer request
Default: 00

Packing Material
Tray: 0 T&R: T

Speed
1C:150MHz

Temperature & Power
Industrial: I

Package
24-BGA: H

Generation
1st Generation: M

11. Ordering Part Numbers

Table 34: Ordering Part Number

Temperature Grade	Operating Temperature	Package	Shipping Container	Ordering Part Number
Industrial	-40°C to 85°C	24 BGA	Tray	S3H6408R1M-HI1C000
			Tape and Reel	S3H6408R1M-HI1CT00
			Tray	S3H6408R2M-HI1C000
			Tape and Reel	S3H6408R2M-HI1CT00

12. Package Dimension

24-Ball BGA (6mm x 8mm)

TOP VIEW

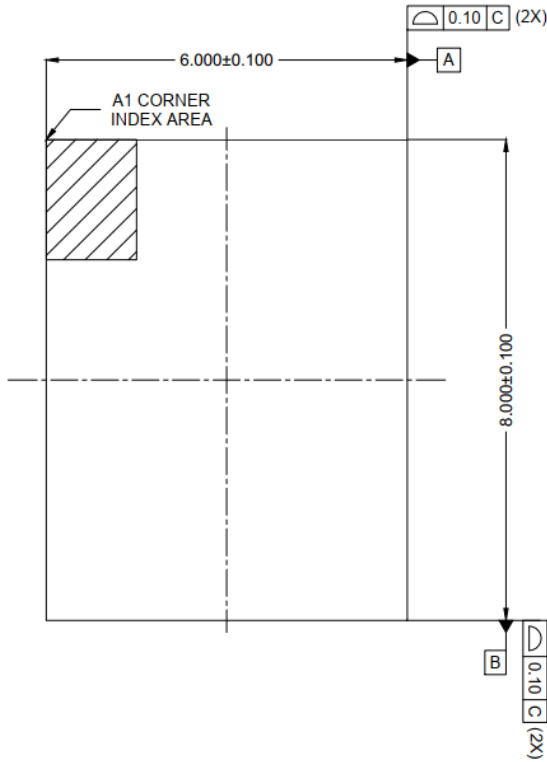

SIDE VIEW

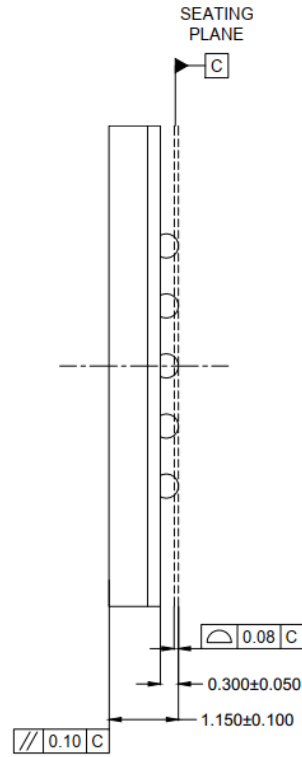

BOTTOM VIEW

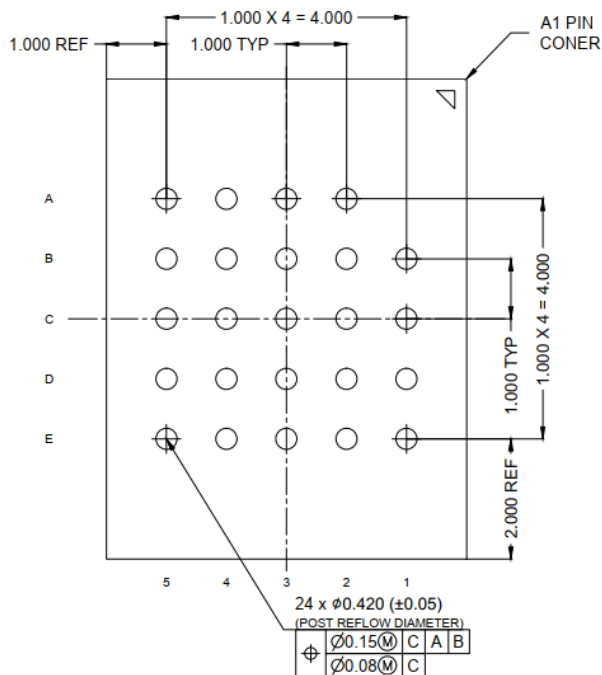

[Notes]

1. All Dimensions in Millimeters
2. RAW SOLDER BALL SIZE IS 0.40mm
3. SRO SIZE IS 0.35mm

Revision History

Revision	Date	Description
0.1	Mar, 2025	Initial Release

* Products and specifications discussed herein are subject to change by Netsol without notice.